

Voltmeter 24 Volt	TU00-0752-5407102	03/11	1-5	1

Safety information



- The product was developed, manufactured and inspected according to the basic safety requirements of EC Guidelines and state-of-the-art technology.
- The instrument is designed for use in grounded vehicles and machines as well as in pleasure boats, including non-classified commercial shipping.
- Use our product only as intended. Use of the product for reasons other than its intended use may lead to personal injury, property damage or environmental damage. Before installation, check the vehicle documentation for vehicle type and any possible special features!
- Use the assembly plan to learn the location of the fuel/hydraulic/ compressed air and electrical lines!
- Note possible modifications to the vehicle, which must be considered during installation!
- To prevent personal injury, property damage or environmental damage, basic knowledge of motor vehicle/shipbuilding electronics and mechanics is required.
- Make sure that the engine cannot start unintentionally during installation!
- Modifications or manipulations to VDO products can affect safety. Consequently, you may not modify or manipulate the product!
- When removing/installing seats, covers, etc., ensure that lines are not damaged and plug-in connections are not loosened!
- Note all data from other installed instruments with volatile electronic memories.

Safety during installation:

- During installation, ensure that the product's components do not affect or limit vehicle functions. Avoid damaging these components!
- Only install undamaged parts in a vehicle!
- During installation, ensure that the product does not impair the field of vision and that it cannot impact the driver's or passenger's head!
- A specialized technician should install the product. If you install the product yourself, wear appropriate work clothing. Do not wear loose clothing, as it may get caught in moving parts. Protect long hair with a hair net.
- When working on the on-board electronics, do not wear metallic or conductive jewelry such as necklaces, bracelets, rings, etc.
- If work on a running engine is required, exercise extreme caution. Wear only appropriate work clothing as you are at risk of personal injury, resulting from being crushed or burned.
- Before beginning, disconnect the negative terminal on the battery, otherwise you risk a short circuit. If the vehicle is supplied by auxiliary batteries, you must also disconnect the negative terminals on these batteries! Short circuits can cause fires, battery explosions and damages to other electronic systems. Please note that when you disconnect the battery, all volatile electronic memories lose their input values and must be reprogrammed.
- If working on gasoline boat motors, let the motor compartment fan run before beginning work.
- Pay attention to how lines and cable harnesses are laid so that you do not drill or saw through them!
- Do not install the product in the mechanical and electrical airbag area!
- Do not drill holes or ports in load-bearing or stabilizing stays or tie bars!
- When working underneath the vehicle, secure it according to the specifications from the vehicle manufacturer.
- Note the necessary clearance behind the drill hole or port at the installation location. Required mounting depth: 65 mm.
- Drill small ports; enlarge and complete them, if necessary, using taper milling tools, saber saws, keyhole saws or files. Debur edges. Follow the safety instructions of the tool manufacturer.
- Use only insulated tools, if work is necessary on live parts.
- Use only the multimeter or diode test lamps provided, to measure voltages and currents in the vehicle/machine or boat. Use of conventional test lamps can cause damage to control units or other electronic systems.

No smoking! No open fire or lights!

- The electrical indicator outputs and cables connected to them must be protected from direct contact and damage. The cables in use must have sufficient insulation and electric strength and the contact points must be safe from touch.
- Use appropriate measures to also protect the electrically conductive parts on the connected consumer from direct contact. Laying metallic, uninsulated cables and contacts is prohibited.

Safety after installation:

- Connect the ground cable tightly to the negative terminal of the battery.
- Reenter/reprogram the volatile electronic memory values.
- Check all functions.
- Use only clean water to clean the components. Note the Ingress Protection (IP) ratings (IEC 60529).

Electrical connection:

- Note cable cross-sectional area!
- Reducing the cable cross-sectional area leads to higher current density, which can cause the cable cross-sectional area in question to heat up!
- When installing electrical cables, use the provided cable ducts and harnesses; however, do not run cables parallel to ignition cables or to cables that lead to large electricity consumers.
- Fasten cables with cable ties or adhesive tape. Do not run cables over moving parts. Do not attach cables to the steering column!
- Ensure that cables are not subject to tensile, compressive or shearing forces.
- If cables are run through drill holes, protect them using rubber sleeves or the like.
- Use only one cable stripper to strip the cable. Adjust the stripper so that stranded wires are not damaged or separated.
- Use only a soft soldering process or commercially available crimp connector to solder new cable connections!
- Make crimp connections with cable crimping pliers only. Follow the safety instructions of the tool manufacturer.
- Insulate exposed stranded wires to prevent short circuits.
- Caution: Risk of short circuit if junctions are faulty or cables are damaged.
- Short circuits in the vehicle network can cause fires, battery explosions and damages to other electronic systems. Consequently, all power supply cable connections must be provided with weldable connectors and be sufficiently insulated.
- Ensure ground connections are sound.
- Faulty connections can cause short circuits. Only connect cables according to the electrical wiring diagram.
- If operating the instrument on power supply units, note that the power supply unit must be stabilized and it must comply with the following standard: DIN EN 61000, Parts 6-1 to 6-4.

Voltmeter 24 Volt	TU00-0752-5407102	03/11	1-5	2

Procedures for installing VDO Viewline instruments

1  Before beginning, turn off the ignition and remove the ignition key. If necessary, remove the main circuit switch.

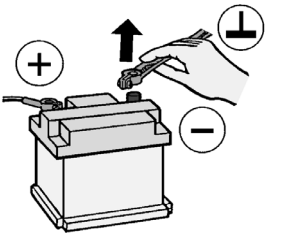
2  Disconnect the negative terminal on the battery. Make sure the battery cannot unintentionally restart.

- Before beginning, disconnect the negative terminal on the battery, otherwise you risk a short circuit. If the vehicle is supplied by auxiliary batteries, you must also disconnect the negative terminals on these batteries! Short circuits can cause fires, battery explosions and damages to other electronic systems. Please note that when you disconnect the battery, all volatile electronic memories lose their input values and must be reprogrammed.

3  If installing the instrument near a magnetic compass, note the magnetic safe distance to the compass.

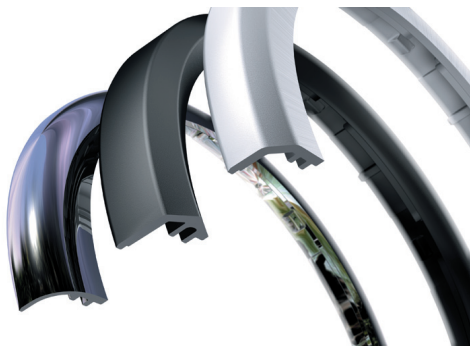
4  The following rings may be installed as alternatives to the supplied front ring:

Front ring, flat; black	A2C53186040
Front ring, flat; white	A2C53186022
Front ring, flat; chrome	A2C53186023
Front ring, triangular; black	A2C53186024
Front ring, triangular; white	A2C53186025
Front ring, triangular; chrome	A2C53186026
Front ring, round; black	A2C53186027
Front ring, round; white	A2C53186028
Front ring, round; chrome	A2C53186029

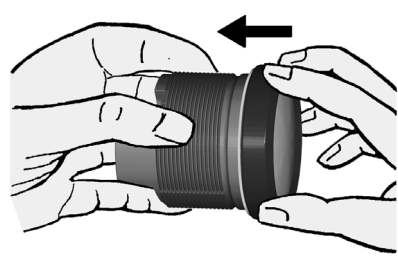
5  Place the new front ring on the instrument and press it on until it is flush with the instrument glass.

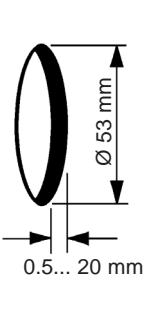
6  Conventional assembly. (Instrument is put into the drill hole from the front). The panel width may be within a range of 0.5 to 20 mm. The drill hole must have a diameter of 53 mm.

- Do not drill holes or ports in load-bearing or stabilizing stays or tie bars!
- Note the necessary clearance behind the drill hole or port at the installation location. Required mounting depth: 65 mm.
- Drill small ports; enlarge and complete them, if necessary, using taper milling tools, saber saws, keyhole saws or files. Deburr edges. Follow the safety instructions of the tool manufacturer.

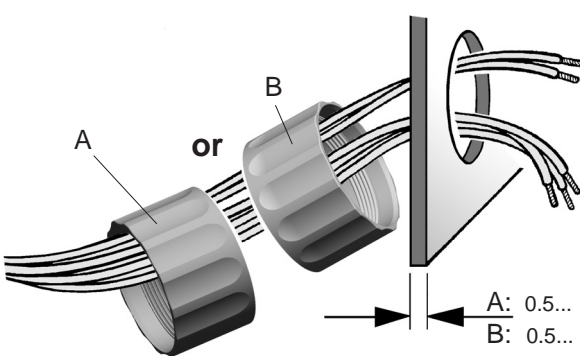
7  For 52 mm instruments, the fastening nut can be mounted at position A or B. This allows you to realize various clamping heights.

Version A
Clamping height 0.5 – 10 mm

Version B
Clamping height 0.5 – 20 mm

A: 0.5... 10 mm
B: 0.5... 20 mm

TU00-0752-5407102

Voltmeter 24 Volt	TU00-0752-5407102	03/11	1-5	3

8

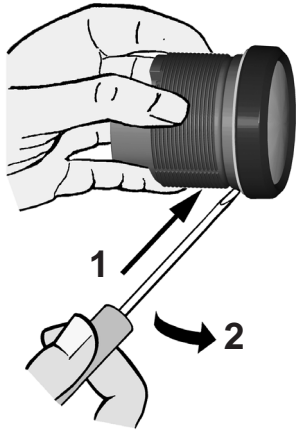

If the instrument is mounted flush (i.e., from the back so that the instrument glass and the panel form one plane), the front ring must be removed. Press the instrument glass with both thumbs, while at the same time pressing the front ring forward from the instrument with both index fingers. Note the use of a tool in the adjacent figure.

9

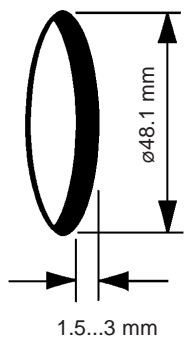

- Do not drill holes or ports in load-bearing or stabilizing stays or tie bars!
- Note the necessary clearance behind the drill hole or port at the installation location. Required mounting depth: 65 mm.
- Drill small ports; enlarge and complete them, if necessary, using taper milling tools, saber saws, keyhole saws or files. Debur edges. Follow the safety instructions of the tool manufacturer.

Flush assembly

The recommended panel thickness is 1.5 to 3 mm. The drill hole must have a diameter of 48.1 mm. Ensure that the installation location is level and has no sharp edges.

10

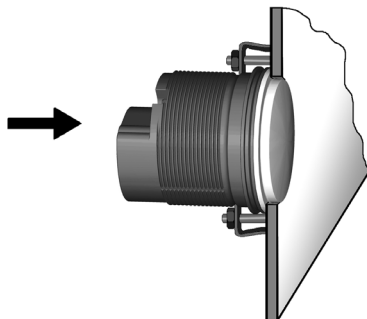

Place the flush mount seal A2C53215640 on the instrument glass. Put the instrument into the drill hole from the back. Adjust the instrument so that the gauge is level and fasten it to the stud bolts on the rear side of the panel, using the flush mount fixing bracket A2C59510864.

11

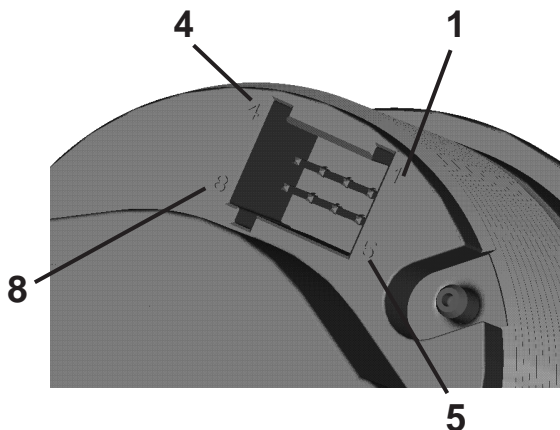

Depending on the configuration, insert the cable into the 8-pin contact enclosure according to the following pin assignment. The contacts must audibly lock into place.

- Pin 1 - Term. 15 - ignition plus 24 V
- Pin 2 - Term. 31 - ground
- Pin 3 - unassigned
- Pin 4 - unassigned
- Pin 5 - unassigned
- Pin 6 - Term. 58 - lighting
- Pin 7 - warning LED ground
- Pin 8 - warning LED plus

Now insert the plug into the gauge. Note the inverse polarity protection nose in the process.

Voltmeter 24 Volt	TU00-0752-5407102	03/11	1-5	4

12

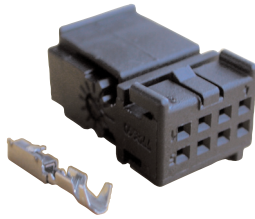

Connector set, 8-pin - A2C59510850

Use the following connector to connect the instrument: Connector set, 8-pin - A2C59510850

The connector set is designed for a cable cross-section of 0.25 - 0.5 mm².

For other cross-sections, please use contacts made by Tyco.

Single contacts: Tyco No. 1355718-1 for 0.14 – 0.22 mm²

Tyco No. 963729-1 for 0.5 – 0.75 mm²

Strip: Tyco No. 1355717-1 for 0.14 – 0.22 mm²

Tyco No. 963715-1 for 0.5 – 0.75 mm²

Create a crimp connection using the contacts and the corresponding cables. Follow the instructions of the hand pliers manufacturer.

Use the following for this:

Hand pliers Tyco No. 539635-1

And the tool Tyco No. 539682-2 for these hand pliers

Pay special attention to whether the crimp barrel clutches all individual wires in the cable, otherwise you risk a short circuit!



Electrical connection:

- Note cable cross-sectional area!
- Reducing the cable cross-sectional area leads to higher current density, which can cause the cable cross-sectional area in question to heat up!
- When installing electrical cables, use the provided cable ducts and harnesses; however, do not run cables parallel to ignition cables or to cables that lead to large electricity consumers.
- Fasten cables with cable ties or adhesive tape. Do not run cables over moving parts. Do not attach cables to the steering column!
- Ensure that cables are not subject to tensile, compressive or shearing forces.
- If cables are run through drill holes, protect them using rubber sleeves or the like.
- Use only one cable stripper to strip the cable. Adjust the stripper so that stranded wires are not damaged or separated.
- Use only a soft soldering process or commercially available crimp connector to solder new cable connections!
- Make crimp connections with cable crimping pliers only. Follow the safety instructions of the tool manufacturer.
- Insulate exposed stranded wires to prevent short circuits.
- Caution: Risk of short circuit if junctions are faulty or cables are damaged.
- Short circuits in the vehicle network can cause fires, battery explosions and damages to other electronic systems. Consequently, all power supply cable connections must be provided with weldable connectors and sufficiently insulated.
- Ensure ground connections are sound.
- Faulty connections can cause short circuits. Only connect cables according to the electrical wiring diagram.
- If operating the instrument on power supply units, note that the power supply unit must be stabilized and it must comply with the following standard: DIN EN 61000, Parts 6-1 to 6-4.

13

Designations in the wiring diagram:

15 - terminal 15 - connected (ignition) plus 24 V

58 - terminal 58 - lighting

31 - terminal 31 - ground

You must comply with the wiring diagram.

F1 - fuse 5A quick-response

C1 - 8-pin MQS connector

Connection 24 V Warning contact minus, connected

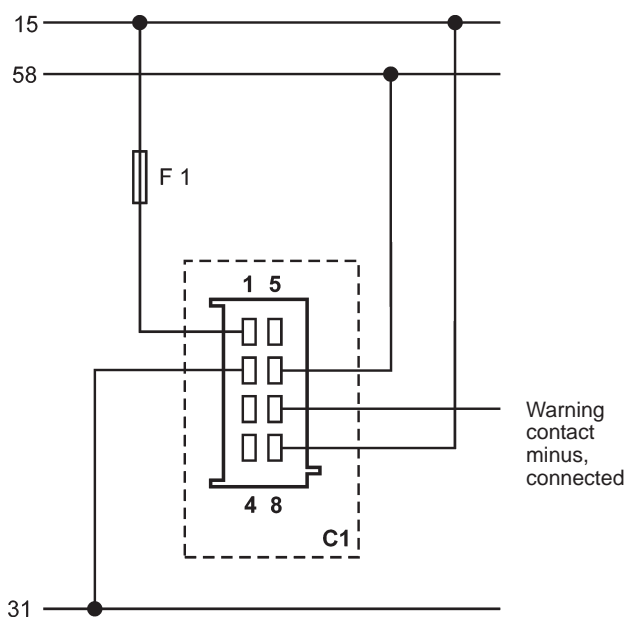

Connection 24 V Warning contact plus, connected

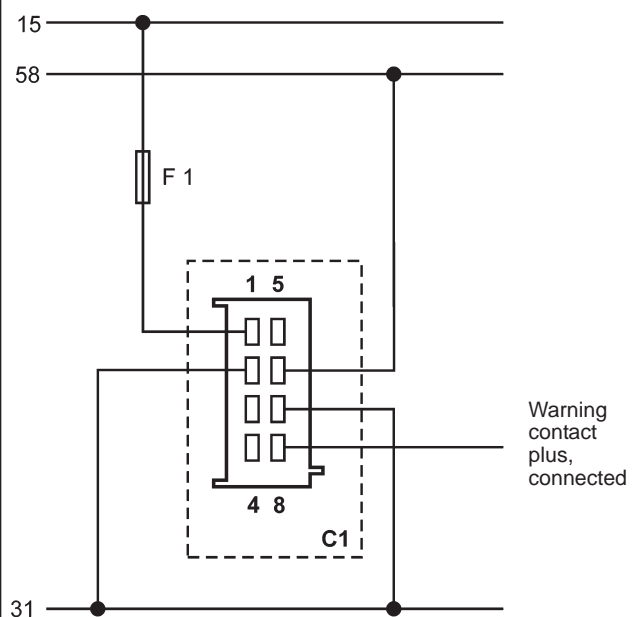

TU00-0752-5407102

Voltmeter 24 Volt	TU00-0752-5407102	03/11 	1-5 5																																																	
<p>14</p>	<p>Align the instrument and hand-tighten the fastening nut. Ensure that the nut is not tightened with a torque greater than 400 Ncm.</p> <p>* Make sure the seal lays flat between the panel and the front ring.</p>																																																			
<p>15</p>	<p>If you would like to omit the fastening nut, you may use the part set A2C59510854 as an alternative. This is recommended if the installation location is subject to vibratory loads. Screw the stud bolts into the provided drill holes in the enclosure. Max. stud bolt torque is 1.5 Nm.</p>																																																			
<p>16</p>	<p>Place the bracket on the stud bolt and hand-tighten the knurled nut.</p> <p>* Make sure the seal lays flat between the panel and the front ring (see Fig. 14).</p>																																																			
<p>17</p>	<p>Reconnect the battery after inspecting the connection.</p> <div style="border: 1px solid black; padding: 5px; margin-top: 10px;"> <ul style="list-style-type: none"> • Please note that when you disconnect the battery, all volatile electronic memories lose their input values and must be reprogrammed. </div>																																																			
<p>18</p>	<p>If necessary, replace the main circuit switch. Turn on the ignition and conduct a functional test. Reprogram any other instruments that may have lost their saved settings.</p>																																																			
<p>19 Important: Clean the instrument glass and front frame with water only. Do not use chemical agents.</p>																																																				
<p>20 Accessories / Spare parts</p> <table border="0" style="width: 100%; border-collapse: collapse;"> <tr> <td style="width: 33%;">Bush contacts 0.25 – 0.5 mm²</td> <td style="width: 33%;">A2C59510846</td> <td style="width: 33%;">Front ring, flat; black</td> <td style="width: 33%;">A2C53186040</td> </tr> <tr> <td>Bush housing, 8-pin</td> <td>A2C59510847</td> <td>Front ring, flat; white</td> <td>A2C53186022</td> </tr> <tr> <td>Hand pliers</td> <td>Tyco No. 539635-1</td> <td>Front ring, flat; chrome</td> <td>A2C53186023</td> </tr> <tr> <td>Tool for hand pliers</td> <td>Tyco No. 539682-2.</td> <td>Front ring, triangular; black</td> <td>A2C53186024</td> </tr> <tr> <td>Single contacts 0.14 – 0.22 mm²</td> <td>Tyco No. 1355718-1</td> <td>Front ring, triangular; white</td> <td>A2C53186025</td> </tr> <tr> <td>Single contacts 0.5 – 0.75 mm²</td> <td>Tyco No. 963729-1</td> <td>Front ring, triangular; chrome</td> <td>A2C53186026</td> </tr> <tr> <td>Strip 0.14 – 0.22 mm²</td> <td>Tyco No. 1355717-1</td> <td>Front ring, round; black</td> <td>A2C53186027</td> </tr> <tr> <td>Strip 0.25 – 0.5 mm²</td> <td>Tyco No. 928999-1</td> <td>Front ring, round; white</td> <td>A2C53186028</td> </tr> <tr> <td>Strip 0.5 – 0.75 mm²</td> <td>Tyco No. 963715-1</td> <td>Front ring, round; chrome</td> <td>A2C53186029</td> </tr> <tr> <td>Bracket assembly mounting set</td> <td>A2C59510854</td> <td>Protective connector cap, 8-pin</td> <td>A2C53324664</td> </tr> <tr> <td>Flush mount fixing bracket</td> <td>A2C59510864</td> <td></td> <td></td> </tr> <tr> <td>Flush mount seal</td> <td>A2C53215640</td> <td></td> <td></td> </tr> <tr> <td>Fastening nut</td> <td>A2C53007398</td> <td></td> <td></td> </tr> </table>	Bush contacts 0.25 – 0.5 mm ²	A2C59510846	Front ring, flat; black	A2C53186040	Bush housing, 8-pin	A2C59510847	Front ring, flat; white	A2C53186022	Hand pliers	Tyco No. 539635-1	Front ring, flat; chrome	A2C53186023	Tool for hand pliers	Tyco No. 539682-2.	Front ring, triangular; black	A2C53186024	Single contacts 0.14 – 0.22 mm ²	Tyco No. 1355718-1	Front ring, triangular; white	A2C53186025	Single contacts 0.5 – 0.75 mm ²	Tyco No. 963729-1	Front ring, triangular; chrome	A2C53186026	Strip 0.14 – 0.22 mm ²	Tyco No. 1355717-1	Front ring, round; black	A2C53186027	Strip 0.25 – 0.5 mm ²	Tyco No. 928999-1	Front ring, round; white	A2C53186028	Strip 0.5 – 0.75 mm ²	Tyco No. 963715-1	Front ring, round; chrome	A2C53186029	Bracket assembly mounting set	A2C59510854	Protective connector cap, 8-pin	A2C53324664	Flush mount fixing bracket	A2C59510864			Flush mount seal	A2C53215640			Fastening nut	A2C53007398		
Bush contacts 0.25 – 0.5 mm ²	A2C59510846	Front ring, flat; black	A2C53186040																																																	
Bush housing, 8-pin	A2C59510847	Front ring, flat; white	A2C53186022																																																	
Hand pliers	Tyco No. 539635-1	Front ring, flat; chrome	A2C53186023																																																	
Tool for hand pliers	Tyco No. 539682-2.	Front ring, triangular; black	A2C53186024																																																	
Single contacts 0.14 – 0.22 mm ²	Tyco No. 1355718-1	Front ring, triangular; white	A2C53186025																																																	
Single contacts 0.5 – 0.75 mm ²	Tyco No. 963729-1	Front ring, triangular; chrome	A2C53186026																																																	
Strip 0.14 – 0.22 mm ²	Tyco No. 1355717-1	Front ring, round; black	A2C53186027																																																	
Strip 0.25 – 0.5 mm ²	Tyco No. 928999-1	Front ring, round; white	A2C53186028																																																	
Strip 0.5 – 0.75 mm ²	Tyco No. 963715-1	Front ring, round; chrome	A2C53186029																																																	
Bracket assembly mounting set	A2C59510854	Protective connector cap, 8-pin	A2C53324664																																																	
Flush mount fixing bracket	A2C59510864																																																			
Flush mount seal	A2C53215640																																																			
Fastening nut	A2C53007398																																																			

TU00-0752-5407102