



Diesel Replacement parts 07/2019

Diesel Ersatzteile

Pièces diesel

Piezas diesel

Diesel Parti

Дизель Запчасти





Diesel Replacement parts

07/2019

Diesel Ersatzteile, Pièces diesel, Piezas diesel, Diesel Parti, Дизель Запчасти

	About Us Über uns A propos de nous Acerca de nosotros Chi siamo О нас	2
	Product Overview Produktübersicht Présentation du produit Descripción del producto Panoramica prodotti Обзор Продукта	3
	Product Information Produktinformationen Information produit Información del producto Informazioni sul prodotto Информация О Продукте	7
	Manufacturer Index Herstellerverzeichnis Les fabricants Directorio de fabricantes Elenco produttori Каталог марок и моделей	23
	Product Application Produktverwendungen Utilisations du produit Aplicaciones el producto Usi del prodotto Подбор по автомобилю	27
	Cross-Reference List Referenzliste Liste de référence Lista de referencia Lista di referenze Список Литературы	71
	Symbols and Abbreviations Symbole und Abkürzungen Symboles et abréviations Símbolos y abreviaturas Simboli e abbreviazioni Символы и сокращения	83



Focused on the future

Working with us, you can look forward to good business. With our wide range of leading-edge products and comprehensive distribution network, we are perfectly set up to meet current and future demands. And we're always interested in hearing our partners' ideas and suggestions.

Our innovative capacity and quality as an original equipment manufacturer are available to you in each product in the replacement parts range – for vehicle diagnostics, fuel systems, engine actuators and sensors. It's your guarantee of lasting success in the automotive world of tomorrow.

Das Unternehmen Zukunft

Die Chancen für gemeinsame erfolgreiche Geschäfte stehen gut. Denn mit unserem zukunftsorientierten Produktspektrum und unserem flächendeckenden Vertriebsnetz sind wir für aktuelle wie für kommende Aufgaben erstklassig aufgestellt. Dabei sind für uns die Wünsche und Anregungen unserer Partner jederzeit von großer Bedeutung.

Mit jedem unserer Produkte im Kfz-Ersatzteilebereich – von der Fahrzeugdiagnose über Kraftstoffsysteme und Motorstellenelemente bis hin zu Sensoren – stehen Ihnen die Innovationskraft und Qualität des Erstausrüsters zur Verfügung. Serienmäßig, als langfristige Erfolgsgaranten in der automotiven Welt von morgen.

L'entreprise du futur

Les chances de réaliser ensemble des affaires fructueuses sont bonnes. En effet, avec notre gamme de produits porteuse d'avenir et notre vaste réseau de distribution, nous sommes parfaitement à même d'accomplir les tâches du présent et de l'avenir, d'autant plus que les souhaits et les suggestions de nos partenaires revêtent toujours une grande importance pour nous.

Avec chacun de nos produits du secteur des pièces de rechange pour véhicules – du diagnostic automobile aux capteurs en passant par les circuits de carburant et les éléments de réglage du moteur – vous bénéficiez de la force d'innovation et de la qualité de l'équipementier de première monte. Ces produits de série sont des garants durables du succès dans le monde automobile de demain.

La empresa futura

Se presentan buenas oportunidades para realizar negocios conjuntos colmados de éxito, ya que, con nuestra gama de productos orientada al futuro y nuestra red de distribución de cobertura global, somos los líderes a la hora de llevar a cabo las tareas actuales y venideras. Además, para nosotros, los deseos y las sugerencias de nuestros socios tienen siempre la máxima relevancia.

Con cada uno de nuestros productos del sector de piezas de recambio para el automóvil – desde el diagnóstico del vehículo hasta los sensores, pasando por los sistemas de combustible y los elementos de ajuste del motor –, usted dispone de la fuerza innovadora y la calidad del proveedor de equipo original. De serie, para garantizarle el éxito a largo plazo en el mundo de la automoción del mañana.

Il futuro dell'azienda

Vi sono ottime opportunità di successo per la nostra e vostra attività commerciale. Con la nostra gamma di prodotti di avanzata tecnologia e la nostra ampia rete di distribuzione siamo perfettamente posizionati sia rispetto al presente che al futuro. I suggerimenti e le esigenze dei nostri partners sono per noi sempre di grande importanza.

Tutti i nostri prodotti del settore automotive, dagli apparecchi diagnostici ai sistemi di alimentazione, dagli attuatori motore ai sensori, sono realizzati in modo innovativo e con la elevata qualità propria di una azienda produttrice di sistemi destinati al primo equipaggiamento. Garanzia di successo immediato ed a lungo termine per il settore automobilistico di oggi e di domani.

Предприятие - будущее

Хорошие шансы для успешного совместного бизнеса. Так как с нашим ориентированным на будущее спектром продукции и нашей ширококомасштабной сбытовой сетью мы прекрасно подготовлены к решению текущих и будущих задач. При этом пожелания и предложения партнеров имеют для нас всегда большое значение.

В каждом из наших изделий в области автомобильных запасных деталей, начиная от диагностики автомобилей, топливных систем и исполнительных механизмов и заканчивая датчиками, Вы получаете в Ваше распоряжение инновационную силу и качество изготовителя оригинальных запчастей. Серийно, от гаранта долгосрочного успеха в автомобильном мире завтрашнего дня.



Product Overview

Produktübersicht

Présentation du produit

Descripción del producto

Panoramica prodotti

Обзор Продукта



Common Rail Diesel Injector

Our piezo servo injectors ensure extremely precise injection and ultra-fine atomisation of diesel fuel for highly efficient combustion. Direct-drive piezo injectors make it possible to achieve greater fuel efficiency in powerful engines.

Common Rail Diesel Injektor

Unsere Piezo Servo Injektoren sorgen durch äußerst präzise Einspritzung und feinste Zerstäubung des Dieselkraftstoffs für eine hohe Effizienz in der Verbrennung. Mit den direktangetriebenen Piezo Injektoren können bei leistungsstarken Motoren zusätzliche Potenziale hinsichtlich der effizienten Kraftstoffverbrennung ausgeschöpft werden.

Injecteur diesel common rail

Nos servo-injecteurs piézoélectriques garantissent une efficacité élevée dans la combustion grâce à une injection extrêmement précise et à une pulvérisation très fine du carburant diesel. Avec les injecteurs piézoélectriques à commande directe, des potentiels supplémentaires en matière d'efficacité de combustion du carburant peuvent être exploités sur les moteurs de forte puissance.

Inyectora diésel para sistemas Common Rail

Nuestros servoinyectores piezo contribuyen a una elevada eficiencia en la combustión gracias a su inyección extremadamente precisa y la atomización finísima del combustible diésel. Con los inyectores piezo de accionamiento directo pueden aprovecharse nuevos potenciales en cuanto a la combustión eficiente del carburante en los motores de gran potencia.

Iniettori diesel common rail

I nostri iniettori piezoelettrici garantiscono una iniezione di alta precisione ed una fine atomizzazione del carburante diesel per una elevata efficienza della combustione. Con l'azionamento diretto dell'attuatore piezoelettrico dell'iniettore, tutte le condizioni di funzionamento dei moderni potenti motori sono soddisfatte.

Форсунки для систем впрыска с общим нагнетательным трубопроводом типа Common Rail

Наши форсунки с пьезоуправлением благодаря чрезвычайно прецизионному впрыскиванию и мельчайшему распылению дизельного топлива обеспечивают высокую эффективность сгорания. С помощью форсунок Piezo прямого действия можно в мощных двигателях использовать дополнительный потенциал в отношении эффективного сгорания топлива.



Diesel Common Rail Pump

Our high-pressure diesel pumps have been specially developed for the latest generation of common rail diesel injection systems. They enable a compact design and low weight, and are dimensioned for pressures up to 2,500 bar.

Continental's diesel common rail systems offer the following advantages:

- Compliance with current and future emission limits.
- Reduced CO₂ emissions
- Increased performance, with lower fuel consumption and quiet operation

Diesel Common Rail Pumpe

Unsere Diesel Hochdruckpumpen wurden speziell für die neueste Generation der Diesel Common Rail Einspritzsysteme entwickelt. Ihr Konzept ermöglicht eine kompakte Bauweise und ein geringes Gewicht. Die Auslegung unterstützt Drücke bis zu 2.500 bar.

Damit bieten Continentals Diesel Common Rail Systeme folgende Vorteile:

- Einhaltung aktueller und künftiger Abgasgrenzwerte
- Senkung des CO₂-Ausstoßes
- Gesteigerte Leistung bei reduziertem Verbrauch und optimierter Laufruhe



Pompe diesel common rail

Nos pompes haute pression diesel common rail ont été spécialement développées pour la toute dernière génération de systèmes d'injection diesel common rail. Leur conception permet une construction compacte et un faible poids. Leur dimensionnement supporte des pressions jusqu'à 2 500 bars. Ainsi, les systèmes diesel Common Rail de Continental offrent les avantages suivants :

- Respect des valeurs limites actuelles et futures pour les gaz d'échappement.
- Réduction des émissions de CO₂.
- Performances améliorées pour une consommation réduite et une stabilité de marche optimisée.

Bomba diésel para sistemas Common Rail

Nuestras bombas diésel de alta presión fueron especialmente desarrolladas para la última generación de sistemas de inyección diésel Common Rail. Su diseño posibilita una construcción compacta y un peso reducido. La concepción permite presiones de hasta 2.500 bares.

Por esta razón, los sistemas diésel Common Rail de Continental ofrecen las siguientes ventajas:

- El cumplimiento de los límites de emisiones de escape actuales y futuros
- La reducción de la emisión de CO₂
- El incremento de la potencia con consumo reducido y estabilidad de marcha optimizada

Pompe diesel common rail

Le nostre pompe ad alta pressione sono state progettate specificamente per l'ultima generazione di sistemi di iniezione common rail diesel. La loro concezione consente un design compatto ed un basso peso. Sono realizzate per sopportare pressioni sino a 2500 bar.

L'offerta di Continental di sistemi Common Rail garantisce i seguenti vantaggi :

- Conformità ai limiti di emissioni attuali e futuri
- Riduzione delle emissioni di CO₂
- Aumento delle prestazioni, consumi ridotti e funzionamento ottimizzato

Насосы для систем впрыска с общим нагнетательным трубопроводом типа Common Rail

Наши дизельные насосы высокого давления были специально разработаны для новейшего поколения систем впрыска с общим нагнетательным трубопроводом типа Common Rail. Их концепция обеспечивает компактность конструкции и незначительный вес. Расчетное давление составляет до 2.500 бар.

Тем самым системы впрыска с нагнетательным трубопроводом типа Piezo-Common Rail фирмы Continental дают следующие преимущества:

- Соблюдение текущих и будущих предельных показателей выброса ОГ
- Снижение выброса CO₂
- Повышение мощности при снижении расхода и оптимизированный плавный ход

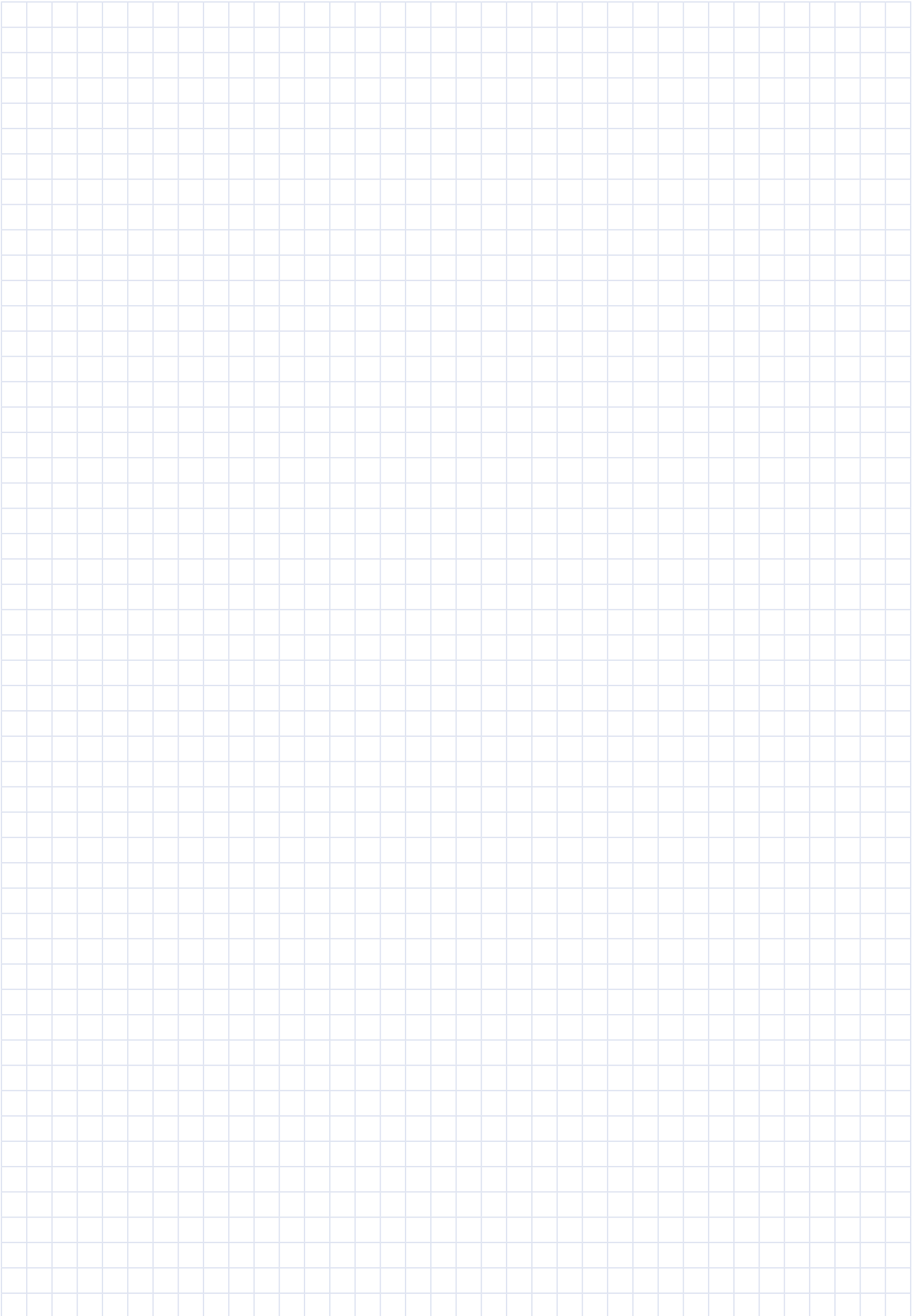



Product Information

Produktinformationen

Information produit

Información del producto

Informazioni sul prodotto

Информация О Продукте



2910000177400

**Common Rail Diesel Injector**

Diesel (V65)

Part number of recommended accessories (C31): A2C59514036

Observe the vehicle manufacturer specifications (C27)

T019: Have to be taught/updated.

T024: Mandatory - check new part against old part (in particular OE No.)

LAND ROVER

DEFENDER Cabrio (L316) / DEFENDER Pickup (L316) / DEFENDER Platform/Chassis (L316) / DEFENDER Station Wagon (L316)

5WS4000-Z

**Common Rail Diesel Injector**

Diesel (V65)

Part number of recommended accessories (C31): X11-800-002-002Z

Observe the vehicle manufacturer specifications (C27)

T024: Mandatory - check new part against old part (in particular OE No.)

CITROËN

BERLINGO / BERLINGO FIRST Box (M_) / BERLINGO / BERLINGO FIRST MPV (MF, GJK, GFK) / C5 I (DC_) / C5 I Break (DE_) / XSARA (N1) / XSARA Break (N2) / XSARA Coupe (N0)

PEUGEOT

307 (3A/C) / 307 Break (3E) / 307 SW (3H) / 406 (8B) / 406 Break (8E/F) / PARTNER Box (5) / PARTNER Combispace (5F)

5WS40018-Z

**Diesel Common Rail Pump**

Diesel (V65)

Observe the vehicle manufacturer specifications (C27)

T024: Mandatory - check new part against old part (in particular OE No.)

CITROËN

BERLINGO / BERLINGO FIRST Box (M_) / BERLINGO / BERLINGO FIRST MPV (MF, GJK, GFK) / C5 I (DC_) / C5 I Break (DE_) / XSARA (N1) / XSARA Break (N2) / XSARA Coupe (N0)

PEUGEOT

307 (3A/C) / 307 Break (3E) / 307 SW (3H) / 406 (8B) / 406 Break (8E/F) / PARTNER Box (5) / PARTNER Combispace (5F)

5WS40148-Z

**Common Rail Diesel Injector**

Diesel (V65)

Part number of recommended accessories (C31): X11-800-002-004Z

Observe the vehicle manufacturer specifications (C27)

T024: Mandatory - check new part against old part (in particular OE No.)

CITROËN

C3 Pluriel (HB_)

FORD

FUSION (JU_)

PEUGEOT

1007 (KM_)



5WS40156-4Z

**Common Rail Diesel Injector**

Version (C2): Class 4

Diesel (V65)

Part number of recommended accessories (C31): X11-800-002-002Z

Observe the vehicle manufacturer specifications (C27)

T024: Mandatory - check new part against old part (in particular OE No.)

T041: Please note the classification of the injector (4, 5 or 6).

CITROËN

C4 I (LC_) / C4 Coupe (LA_) / C5 II (RC_) / C5 II Break (RE_)

FIAT

SCUDO (270_, 272_) / SCUDO Box (270_, 272_) / SCUDO Platform/Chassis (270_, 272_) / ULYSSE (179_)

FORD

C-MAX (DM2) / FOCUS II (DA_, HCP, DP) / FOCUS II Convertible / FOCUS II Saloon (DB_, FCH, DH) / FOCUS II Turnier (DA_, FFS, DS) / FOCUS C-MAX (DM2) / GALAXY (WM) / KUGA I / MONDEO IV (BA7) / MONDEO IV Saloon (BA7) / MONDEO IV Turnier (BA7) / S-MAX (WS)

PEUGEOT

307 (3A/C) / 307 Break (3E) / 307 CC (3B) / 307 SW (3H) / 407 (6D_) / 407 Coupe (6C_) / 407 SW (6E_) / 807 (E) / EXPERT Box (VF3A_, VF3U_, VF3X_) / EXPERT Platform/Chassis / EXPERT Tepee (VF3X_)

VOLVO

C30 (533) / C70 II Convertible (542) / S40 II (544) / S80 II (124) / V50 (545) / V70 III (135)

5WS40156-Z

**Common Rail Diesel Injector**

Version (C2): Class 5

Diesel (V65)

Part number of recommended accessories (C31): X11-800-002-002Z

Observe the vehicle manufacturer specifications (C27)

T024: Mandatory - check new part against old part (in particular OE No.)

T041: Please note the classification of the injector (4, 5 or 6).

CITROËN

C4 I (LC_) / C4 Coupe (LA_) / C5 II (RC_) / C5 II Break (RE_)

FIAT

SCUDO (270_, 272_) / SCUDO Box (270_, 272_) / SCUDO Platform/Chassis (270_, 272_) / ULYSSE (179_)

FORD

C-MAX (DM2) / FOCUS II (DA_, HCP, DP) / FOCUS II Convertible / FOCUS II Saloon (DB_, FCH, DH) / FOCUS II Turnier (DA_, FFS, DS) / FOCUS C-MAX (DM2) / GALAXY (WM) / KUGA I / MONDEO IV (BA7) / MONDEO IV Saloon (BA7) / MONDEO IV Turnier (BA7) / S-MAX (WS)

PEUGEOT

307 (3A/C) / 307 Break (3E) / 307 CC (3B) / 307 SW (3H) / 407 (6D_) / 407 Coupe (6C_) / 407 SW (6E_) / 607 (9D, 9U) / 807 (E) / EXPERT Box (VF3A_, VF3U_, VF3X_) / EXPERT Platform/Chassis / EXPERT Tepee (VF3X_)

VOLVO

C30 (533) / C70 II Convertible (542) / S40 II (544) / S80 II (124) / V50 (545) / V70 III (135)



5WS40809-Z

**Diesel Common Rail Pump**

Diesel (V65)

Observe the vehicle manufacturer specifications (C27)

T024: Mandatory - check new part against old part (in particular OE No.)

CITROËN

C4 Grand Picasso I (UA_) / C4 Picasso I MPV (UD_) / C5 II (RC_) / C5 II Break (RE_) / C8 (EA_, EB_) / JUMPY (VF7) / JUMPY Box

FIAT

SCUDO (270_, 272_) / SCUDO Box (270_, 272_) / SCUDO Platform/Chassis (270_, 272_) / ULYSSE (179_)

FORD

FOCUS II (DA_, HCP, DP) / FOCUS II Convertible / FOCUS II Saloon (DB_, FCH, DH) / FOCUS II Turnier (DA_, FFS, DS) / FOCUS C-MAX (DM2)

PEUGEOT

307 (3A/C) / 307 Break (3E) / 307 CC (3B) / 307 SW (3H) / 407 (6D_) / 407 Coupe (6C_) / 407 SW (6E_) / 607 (9D, 9U) / 807 (E) / EXPERT Box (VF3A_, VF3U_, VF3X_) / EXPERT Platform/Chassis / EXPERT Tepee (VF3X_)

A2C1637670080

**Diesel Common Rail Pump**

Fuel Mixture Formation (C62): Common Rail (CR)

Diesel (V65)

Observe the vehicle manufacturer specifications (C27)

FORD

FOCUS IV (HN) / FOCUS IV Turnier (HP) / GALAXY (CK) / S-MAX (CJ) / TOURNEO CUSTOM Bus / TRANSIT Box / TRANSIT Bus / TRANSIT CUSTOM Box / TRANSIT CUSTOM Bus / TRANSIT Platform/Chassis

A2C3999700080

**Common Rail Diesel Injector**

Diesel (V65)

Observe the vehicle manufacturer specifications (C27)

T019: Have to be taught/updated.

T024: Mandatory - check new part against old part (in particular OE No.)

A2C5328876880

Distributor Pipe, fuel

Diesel (V65)

Supplementary Article/Info 2 (C106): with sensor (V178)

Observe the vehicle manufacturer specifications (C27)

T024: Mandatory - check new part against old part (in particular OE No.)

FORD

RANGER (TKE) / TOURNEO CUSTOM Bus / TRANSIT Box / TRANSIT Box (FA_) / TRANSIT Bus / TRANSIT Bus (FD_, FB_, FS_, FZ_, FC_) / TRANSIT CUSTOM Box / TRANSIT CUSTOM Bus / TRANSIT Platform/Chassis / TRANSIT Platform/Chassis (FM_, FN_)



A2C5329449880

Cover

for article number (C68): A2C59517047 / A2C59517049

Black (V52)

A2C5338472780

**Diesel Common Rail Pump**

Fuel Mixture Formation (C62): Common Rail (CR)

Diesel (V65)

Observe the vehicle manufacturer specifications (C27)

T019: Have to be taught/updated.

T024: Mandatory - check new part against old part (in particular OE No.)

A2C59507596

**Common Rail Diesel Injector**

Diesel (V65)

Observe the vehicle manufacturer specifications (C27)

T024: Mandatory - check new part against old part (in particular OE No.)

**MERCEDES-BENZ**

A-CLASS (W176) / B-CLASS (W246, W242) / CITAN Box (415) / CITAN Combi (415) / CITAN Mixto (415) / CLA Coupe (C117) / CLA Shooting Brake (X117) / GLA-CLASS (X156)

NISSAN

JUKE (F15) / NV200 / EVALIA Bus / NV200 Box Body / Estate / QASHQAI II Closed Off-Road Vehicle (J11, J11_)

RENAULT

CAPTUR (J5_, H5_) / GRAND SCÉNIC III (JZ0/1_) / KADJAR (HA_, HL_) / KANGOO / GRAND KANGOO (KW0/1_) / KANGOO Express (FW0/1_) / MEGANE III Grandtour (KZ0/1) / MEGANE III Hatchback (BZ0/1_) / SCÉNIC III (JZ0/1_)

A2C59507608

**Diesel Common Rail Pump**

Diesel (V65)

Observe the vehicle manufacturer specifications (C27)

T024: Mandatory - check new part against old part (in particular OE No.)

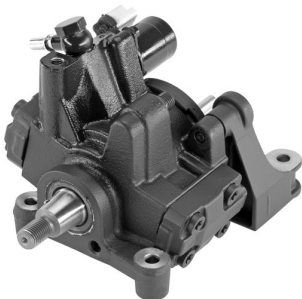
**MERCEDES-BENZ**

A-CLASS (W176) / B-CLASS (W246, W242) / CITAN Box (415) / CITAN Combi (415) / CITAN Mixto (415) / CLA Coupe (C117) / CLA Shooting Brake (X117) / GLA-CLASS (X156)

NISSAN

JUKE (F15) / NV200 / EVALIA Bus / NV200 Box Body / Estate / QASHQAI II Closed Off-Road Vehicle (J11, J11_)

RENAULT

CAPTUR (J5_, H5_) / GRAND SCÉNIC III (JZ0/1_) / KADJAR (HA_, HL_) / KANGOO / GRAND KANGOO (KW0/1_) / KANGOO Express (FW0/1_) / MEGANE III Grandtour (KZ0/1) / MEGANE III Hatchback (BZ0/1_) / SCÉNIC III (JZ0/1_)



A2C59511316

**Common Rail Diesel Injector**

Diesel (V65)

Observe the vehicle manufacturer specifications (C27)

Part number of recommended accessories (C31): X11-800-002-002Z

T024: Mandatory - check new part against old part (in particular OE No.)

CITROËN

C5 III (RD_) / C5 III Break (RW_) / C6 (TD_)

JAGUAR

S-TYPE (X200) / XF (X250)

PEUGEOT

407 (6D_) / 407 Coupe (6C_) / 407 SW (6E_) / 607 (9D, 9U)

A2C59511317

Distributor Pipe, fuel

Diesel (V65)

Fuel Rail (V240)

Observe the vehicle manufacturer specifications (C27)

T024: Mandatory - check new part against old part (in particular OE No.)

CITROËN

C5 III (RD_) / C5 III Break (RW_) / C6 (TD_)

JAGUAR

S-TYPE (X200) / XF (X250)

LAND ROVER

DISCOVERY III (L319) / RANGE ROVER SPORT (L320)

PEUGEOT

407 (6D_) / 407 Coupe (6C_) / 407 SW (6E_) / 607 (9D, 9U)

A2C59511318

Distributor Pipe, fuel

Diesel (V65)



Observe the vehicle manufacturer specifications (C27)

T024: Mandatory - check new part against old part (in particular OE No.)

CITROËN

C5 III (RD_) / C5 III Break (RW_) / C6 (TD_)

JAGUAR

S-TYPE (X200) / XF (X250)

LAND ROVER

DISCOVERY III (L319) / RANGE ROVER SPORT (L320)

PEUGEOT

407 (6D_) / 407 Coupe (6C_) / 407 SW (6E_) / 607 (9D, 9U)

**A2C59511319****Distributor Pipe, fuel** Diesel (V65)

Observe the vehicle manufacturer specifications (C27)

T024: Mandatory - check new part against old part (in particular OE No.)

CITROËN

C5 III (RD_) / C5 III Break (RW_) / C6 (TD_)

JAGUAR

S-TYPE (X200) / XF (X250)

LAND ROVER

DISCOVERY III (L319) / RANGE ROVER SPORT (L320)

PEUGEOT

407 (6D_) / 407 Coupe (6C_) / 407 SW (6E_) / 607 (9D, 9U)

A2C59511364**Common Rail Diesel Injector** Diesel (V65)

Part number of recommended accessories (C31): X11-800-002-002Z

Observe the vehicle manufacturer specifications (C27)

T024: Mandatory - check new part against old part (in particular OE No.)

LAND ROVER

DISCOVERY III (L319) / RANGE ROVER SPORT (L320)

A2C59511600**Diesel Common Rail Pump** Diesel (V65)

Observe the vehicle manufacturer specifications (C27)

T024: Mandatory - check new part against old part (in particular OE No.)

FORD

C-MAX (DM2) / FOCUS II (DA_, HCP, DP) / FOCUS II Convertible / FOCUS II Saloon (DB_, FCH, DH) / FOCUS II Turnier (DA_, FFS, DS) / FOCUS C-MAX (DM2) / GALAXY (WM) / KUGA I / MONDEO IV (BA7) / MONDEO IV Saloon (BA7) / MONDEO IV Turnier (BA7) / S-MAX (WS)

VOLVO

C30 (533) / C70 II Convertible (542) / S40 II (544) / S80 II (124) / V50 (545) / V70 III (135)



A2C59511601

**Common Rail Diesel Injector**

Version (C2): Class 6

Diesel (V65)

Part number of recommended accessories (C31): X11-800-002-002Z

Observe the vehicle manufacturer specifications (C27)

T024: Mandatory - check new part against old part (in particular OE No.)

T041: Please note the classification of the injector (4, 5 or 6).

CITROËN

C4 I (LC_) / C4 Coupe (LA_) / C5 II (RC_) / C5 II Break (RE_)

FIAT

SCUDO (270_, 272_) / SCUDO Box (270_, 272_) / SCUDO Platform/Chassis (270_, 272_) / ULYSSE (179_)

FORD

C-MAX (DM2) / FOCUS II (DA_, HCP, DP) / FOCUS II Convertible / FOCUS II Saloon (DB_, FCH, DH) / FOCUS II Turnier (DA_, FFS, DS) / FOCUS C-MAX (DM2) / GALAXY (WM) / KUGA I / MONDEO IV (BA7) / MONDEO IV Saloon (BA7) / MONDEO IV Turnier (BA7) / S-MAX (WS)

PEUGEOT

307 (3A/C) / 307 Break (3E) / 307 CC (3B) / 307 SW (3H) / 407 (6D_) / 407 Coupe (6C_) / 407 SW (6E_) / 807 (E) / EXPERT Box (VF3A_, VF3U_, VF3X_) / EXPERT Platform/Chassis / EXPERT Tepee (VF3X_)

A2C59511602

**Common Rail Diesel Injector**

Diesel (V65)

Part number of recommended accessories (C31): X11-800-002-002Z

Observe the vehicle manufacturer specifications (C27)

T024: Mandatory - check new part against old part (in particular OE No.)

CITROËN

C8 (EA_, EB_) / JUMPY (VF7) / JUMPY Box

FIAT

SCUDO (270_, 272_) / SCUDO Box (270_, 272_) / SCUDO Platform/Chassis (270_, 272_) / ULYSSE (179_)

PEUGEOT

807 (E) / EXPERT Box (VF3A_, VF3U_, VF3X_) / EXPERT Platform/Chassis / EXPERT Tepee (VF3X_)

A2C59511603

**Common Rail Diesel Injector**

Version (C2): Class M

Diesel (V65)

Part number of recommended accessories (C31): X11-800-002-002Z

Observe the vehicle manufacturer specifications (C27)

T024: Mandatory - check new part against old part (in particular OE No.)

T041: Please note the classification of the injector (4, 5 or 6).

CITROËN

C4 I (LC_) / C4 Coupe (LA_) / C4 Grand Picasso I (UA_) / C4 Picasso I MPV (UD_)

PEUGEOT

307 (3A/C) / 307 Break (3E) / 307 CC (3B) / 307 SW (3H) / 407 (6D_) / 407 Coupe (6C_) / 407 SW (6E_)

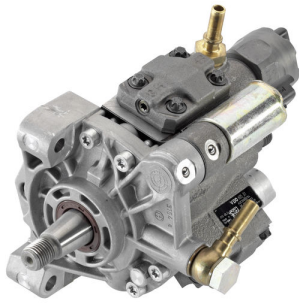

A2C59511605

**Diesel Common Rail Pump**

Diesel (V65)

Observe the vehicle manufacturer specifications (C27)

T024: Mandatory - check new part against old part (in particular OE No.)

NISSAN

NOTE (E11, NE11) / QASHQAI / QASHQAI +2 I (J10, NJ10) / TIIDA Hatchback (C11) / TIIDA Saloon (SC11)

RENAULT

CLIO III (BR0/1, CR0/1) / CLIO Grandtour (KR0/1_) / KANGOO / GRAND KANGOO (KW0/1_) / KANGOO BE BOP (KW0/1_) / KANGOO Express (FW0/1_) / LAGUNA III (BT0/1) / LAGUNA III Grandtour (KT0/1) / MEGANE II (BM0/1_, CM0/1_) / MEGANE II Coupé-Cabriolet (EM0/1_) / MEGANE II Estate (KM0/1_) / MEGANE II Saloon (LM0/1_) / MODUS / GRAND MODUS (F/JP0_) / SCÉNIC II (JM0/1_)

A2C59511606

**Common Rail Diesel Injector**

Diesel (V65)

Observe the vehicle manufacturer specifications (C27)

T024: Mandatory - check new part against old part (in particular OE No.)

NISSAN

NOTE (E11, NE11) / QASHQAI / QASHQAI +2 I (J10, NJ10) / TIIDA Hatchback (C11) / TIIDA Saloon (SC11)

RENAULT

CLIO III (BR0/1, CR0/1) / CLIO Grandtour (KR0/1_) / KANGOO / GRAND KANGOO (KW0/1_) / KANGOO BE BOP (KW0/1_) / KANGOO Express (FW0/1_) / LAGUNA III (BT0/1) / LAGUNA III Grandtour (KT0/1) / MEGANE II (BM0/1_, CM0/1_) / MEGANE II Coupé-Cabriolet (EM0/1_) / MEGANE II Estate (KM0/1_) / MEGANE II Saloon (LM0/1_) / MODUS / GRAND MODUS (F/JP0_) / SCÉNIC II (JM0/1_)

A2C59511609

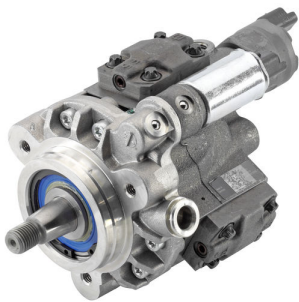
**Diesel Common Rail Pump**

Diesel (V65)

Observe the vehicle manufacturer specifications (C27)

T024: Mandatory - check new part against old part (in particular OE No.)

FORD

C-MAX (DM2) / FOCUS (DAW, DBW) / FOCUS II (DA_, HCP, DP) / FOCUS II Saloon (DB_, FCH, DH) / FOCUS II Turnier (DA_, FFS, DS) / FOCUS C-MAX (DM2) / FOCUS Saloon (DFW) / FOCUS Turnier (DNW) / GALAXY (WM) / MONDEO IV (BA7) / MONDEO IV Saloon (BA7) / MONDEO IV Turnier (BA7) / S-MAX (WS) / TOURNEO CONNECT / TRANSIT CONNECT (P65_, P70_, P80_)



A2C59511610

**Common Rail Diesel Injector**

Diesel (V65)

Part number of recommended accessories (C31): X11-800-002-003Z

Observe the vehicle manufacturer specifications (C27)

T024: Mandatory - check new part against old part (in particular OE No.)

FORD

C-MAX (DM2) / FOCUS (DAW, DBW) / FOCUS II (DA_, HCP, DP) / FOCUS II Saloon (DB_, FCH, DH) / FOCUS II Turnier (DA_, FFS, DS) / FOCUS C-MAX (DM2) / FOCUS Saloon (DFW) / FOCUS Turnier (DNW) / GALAXY (WM) / MONDEO IV (BA7) / MONDEO IV Saloon (BA7) / MONDEO IV Turnier (BA7) / S-MAX (WS) / TOURNEO CONNECT / TRANSIT CONNECT (P65_, P70_, P80_)

A2C59511611

**Common Rail Diesel Injector**

Diesel (V65)

Part number of recommended accessories (C31): X11-800-002-003Z

Observe the vehicle manufacturer specifications (C27)

T024: Mandatory - check new part against old part (in particular OE No.)

FORD

TOURNEO CONNECT / TRANSIT CONNECT (P65_, P70_, P80_)

A2C59511612

**Common Rail Diesel Injector**

Diesel (V65)

Part number of recommended accessories (C31): X11-800-002-004Z

Observe the vehicle manufacturer specifications (C27)

T024: Mandatory - check new part against old part (in particular OE No.)

CITROËN

C2 (JM_) / C2 ENTERPRISE (JG_) / C3 I (FC_, FN_) / C3 II (SC_)

FORD

FIESTA V (JH_, JD_) / FIESTA V Van / FIESTA VI (CB1, CCN) / FIESTA VI Van / FUSION (JU_)

PEUGEOT

107 / 1007 (KM_)

TOYOTA

AYGO (B1_)

A2C59513481

**Diesel Common Rail Pump**

Diesel (V65)

Observe the vehicle manufacturer specifications (C27)

T024: Mandatory - check new part against old part (in particular OE No.)

LAND ROVER

RANGE ROVER III (L322) / RANGE ROVER SPORT (L320)

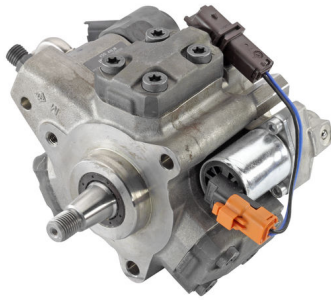

A2C59513482

**Diesel Common Rail Pump**

Diesel (V65)

Observe the vehicle manufacturer specifications (C27)

T024: Mandatory - check new part against old part (in particular OE No.)

LAND ROVER

DISCOVERY III (L319) / DISCOVERY IV (L319) / RANGE ROVER SPORT (L320)

A2C59513484

**Common Rail Diesel Injector**

Diesel (V65)

Observe the vehicle manufacturer specifications (C27)

T019: Have to be taught/updated.

T024: Mandatory - check new part against old part (in particular OE No.)

DACIA

DUSTER / DUSTER Box / LODGY (JS_)

NISSAN

CUBE (Z12) / JUKE (F15) / QASHQAI / QASHQAI +2 I (J10, NJ10)

RENAULT

CLIO III (BR0/1, CR0/1) / CLIO Grandtour (KR0/1_) / FLUENCE (L3_) / GRAND SCÉNIC III (JZ0/1_) / LAGUNA Coupe (DT0/1) / LATITUDE (L70_) / MEGANE III Coupe (DZ0/1_) / MEGANE III Grandtour (KZ0/1) / MEGANE III Hatchback (BZ0/1_) / MEGANE CC (EZ0/1_) / SCÉNIC III (JZ0/1_)

A2C59513553

**Common Rail Diesel Injector**

Diesel (V65)

Part number of recommended accessories (C31): X11-800-002-002Z

Observe the vehicle manufacturer specifications (C27)

T024: Mandatory - check new part against old part (in particular OE No.)

LAND ROVER

DISCOVERY III (L319) / DISCOVERY IV (L319) / RANGE ROVER SPORT (L320)



A2C59513556

**Common Rail Diesel Injector**

Part number of recommended accessories (C31): A2C59514036

Observe the vehicle manufacturer specifications (C27)

T019: Have to be taught/updated.

T024: Mandatory - check new part against old part (in particular OE No.)

CITROËN

BERLINGO (B9) / BERLINGO Box (B9) / BERLINGO Platform/Chassis (B9) / C3 II (SC_) / C3 Picasso / C4 II (B7) / C4 AIRCROSS / C4 Grand Picasso I (UA_) / C4 Picasso I MPV (UD_) / C4 Picasso II / C5 III (RD_) / C5 III Break (RW_) / DS3 / DS4 / DS5

FORD

C-MAX II (DXA/CB7, DXA/CEU) / FOCUS III / FOCUS III Saloon / FOCUS III Turnier / GALAXY (WM) / GRAND C-MAX (DXA/CB7, DXA/CEU) / MONDEO IV (BA7) / MONDEO IV Turnier (BA7) / S-MAX (WS)

MAZDA

3 (BL) / 3 Saloon (BL) / 5 (CW)

PEUGEOT

207 CC (WD_) / 207 SW (WK_) / 208 (CA_, CC_) / 308 (4A_, 4C_) / 308 II / 308 CC (4B_) / 308 SW (4E_, 4H_) / 508 I (8D_) / 508 SW I (8E_) / 2008 (CU_) / 3008 MPV (OU_) / 4008 / 5008 (OU_, OE_) / PARTNER Box / PARTNER Tepee

VOLVO

C30 (533) / S40 II (544) / S60 II (134) / S80 II (124) / V40 Hatchback (525, 526) / V50 (545) / V60 (155, 157) / V70 III (135)

A2C59513595

**Diesel Common Rail Pump**

Diesel (V65)

Observe the vehicle manufacturer specifications (C27)

T024: Mandatory - check new part against old part (in particular OE No.)

DACIA

DUSTER / DUSTER Box / LODGY (JS_)

NISSAN

CUBE (Z12) / JUKE (F15) / QASHQAI / QASHQAI +2 I (J10, NJ10)

RENAULT

CLIO III (BR0/1, CR0/1) / CLIO Grandtour (KR0/1_) / FLUENCE (L3_) / GRAND SCÉNIC III (JZ0/1_) / LAGUNA Coupe (DT0/1) / LATITUDE (L70_) / MEGANE III Coupe (DZ0/1_) / MEGANE III Grandtour (KZ0/1) / MEGANE III Hatchback (BZ0/1_) / MEGANE CC (EZ0/1_) / SCÉNIC III (JZ0/1_)

A2C59513596

**Common Rail Diesel Injector**

Diesel (V65)

Part number of recommended accessories (C31): X11-800-002-002Z

Observe the vehicle manufacturer specifications (C27)

T024: Mandatory - check new part against old part (in particular OE No.)



A2C59513597

**Common Rail Diesel Injector**

Diesel (V65)

Part number of recommended accessories (C31): X11-800-002-002Z

Observe the vehicle manufacturer specifications (C27)

T024: Mandatory - check new part against old part (in particular OE No.)

LAND ROVER

RANGE ROVER III (L322) / RANGE ROVER SPORT (L320)

A2C59513829

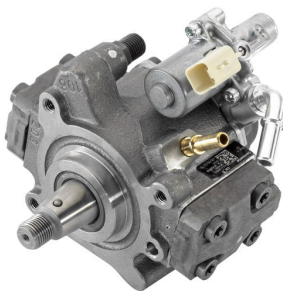
**Diesel Common Rail Pump**

Diesel (V65)

Observe the vehicle manufacturer specifications (C27)

T024: Mandatory - check new part against old part (in particular OE No.)

FORD

C-MAX II (DXA/CB7, DXA/CEU) / FOCUS III / FOCUS III Saloon / FOCUS III Turnier / GALAXY (WM) / GRAND C-MAX (DXA/CB7, DXA/CEU) / MONDEO IV (BA7) / MONDEO IV Turnier (BA7) / S-MAX (WS)

MAZDA

3 (BL) / 3 Saloon (BL) / 5 (CW)

VOLVO

C30 (533) / S40 II (544) / S60 II (134) / S80 II (124) / V40 Hatchback (525, 526) / V50 (545) / V60 (155, 157) / V70 III (135)

A2C59513830

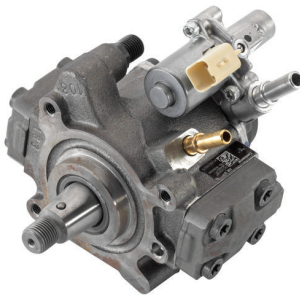
**Diesel Common Rail Pump**

Diesel (V65)

Observe the vehicle manufacturer specifications (C27)

T024: Mandatory - check new part against old part (in particular OE No.)

CITROËN

BERLINGO (B9) / BERLINGO Box (B9) / BERLINGO Platform/Chassis (B9) / C3 II (SC_) / C3 Picasso / C4 II (B7) / C4 AIRCROSS / C4 Grand Picasso I (UA_) / C4 Picasso I MPV (UD_) / C4 Picasso II / C5 III (RD_) / C5 III Break (RW_) / DS3 / DS4 / DS5

PEUGEOT

207 CC (WD_) / 207 SW (WK_) / 208 (CA_, CC_) / 308 (4A_, 4C_) / 308 II / 308 CC (4B_) / 308 SW (4E_, 4H_) / 508 I (8D_) / 508 SW I (8E_) / 2008 (CU_) / 3008 MPV (0U_) / 4008 / 5008 (0U_, 0E_) / PARTNER Box / PARTNER Tepee

A2C59515264

**Common Rail Diesel Injector**

Diesel (V65)

Observe the vehicle manufacturer specifications (C27)

T019: Have to be taught/updated.

T024: Mandatory - check new part against old part (in particular OE No.)



A2C59517043

**Diesel Common Rail Pump**

Diesel (V65)

Observe the vehicle manufacturer specifications (C27)

T024: Mandatory - check new part against old part (in particular OE No.)

FORD

RANGER (TKE) / TRANSIT Box (FA_) / TRANSIT Bus (FD_, FB_, FS_, FZ_, FC_) / TRANSIT Platform/Chassis (FM_, FN_) / TRANSIT TOURNEO

A2C59517045

**Diesel Common Rail Pump**

Diesel (V65)

Observe the vehicle manufacturer specifications (C27)

T024: Mandatory - check new part against old part (in particular OE No.)

CITROËN

JUMPER Box / JUMPER Bus / JUMPER Platform/Chassis

FORD

TOURNEO CUSTOM Bus / TRANSIT Box / TRANSIT Box (FA_) / TRANSIT Bus / TRANSIT Bus (FD_, FB_, FS_, FZ_, FC_) / TRANSIT CUSTOM Box / TRANSIT CUSTOM Bus / TRANSIT Platform/Chassis / TRANSIT Platform/Chassis (FM_, FN_) / TRANSIT TOURNEO

PEUGEOT

BOXER Box / BOXER Bus / BOXER Platform/Chassis

A2C59517047

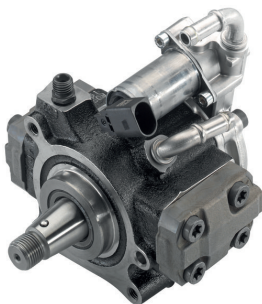
**Diesel Common Rail Pump**

Diesel (V65)

Observe the vehicle manufacturer specifications (C27)

Part number of recommended accessories (C31): A2C5329449880

T024: Mandatory - check new part against old part (in particular OE No.)

AUDI

A1 (8X1, 8XK) / A1 Sportback (8XA, 8XF) / A3 (8P1) / A3 Convertible (8P7) / A3 Sportback (8PA)

SEAT

ALTEA (5P1) / ALTEA XL (5P5, 5P8) / IBIZA IV (6J5, 6P1) / IBIZA IV SPORTCOUPE (6J1, 6P5) / IBIZA IV ST (6J8, 6P8) / LEON (1P1) / TOLEDO IV (KG3)

SKODA

FABIA II (542) / FABIA II Combi (545) / OCTAVIA II (1Z3) / OCTAVIA II Combi (1Z5) / RAPID (NH3) / RAPID Spaceback (NH1) / ROOMSTER (5J) / ROOMSTER Praktik (5J) / SUPERB II (3T4) / SUPERB II Estate (3T5) / YETI (5L)

VW

BEETLE (5C1, 5C2) / BEETLE Convertible (5C7, 5C8) / CADDY III Box (2KA, 2KH, 2CA, 2CH) / CADDY III Estate (2KB, 2KJ, 2CB, 2CJ) / CADDY IV Box (SAA, SAH) / CADDY IV Estate (SAB, SAJ) / GOLF VI (5K1) / GOLF VI Convertible (517) / GOLF VI Variant (AJ5) / GOLF PLUS (5M1, 521) / JETTA III (1K2) / JETTA IV (162, 163, AV3, AV2) / PASSAT (3C2) / PASSAT Variant (3C5) / POLO (6R1, 6C1) / TOURAN (1T3)

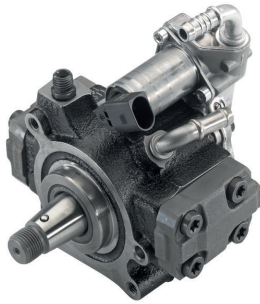

A2C59517049

**Diesel Common Rail Pump**

Diesel (V65)

Observe the vehicle manufacturer specifications (C27)

Part number of recommended accessories (C31): A2C5329449880

T024: Mandatory - check new part against old part (in particular OE No.)

AUDI

A1 (8X1, 8XK) / A1 Sportback (8XA, 8XF)

SKODA

RAPID (NH3) / RAPID Spaceback (NH1)

VW

PASSAT (362) / PASSAT Variant (365) / POLO (6R1, 6C1)

A2C59517051

**Common Rail Diesel Injector**

Diesel (V65)

Part number of recommended accessories (C31): A2C59514036

Observe the vehicle manufacturer specifications (C27)

T019: Have to be taught/updated.

T024: Mandatory - check new part against old part (in particular OE No.)

CITROËN

JUMPER Box / JUMPER Bus / JUMPER Platform/Chassis

FORD

RANGER (TKE) / TOURNEO CUSTOM Bus / TRANSIT Box / TRANSIT Box (FA_) / TRANSIT Bus / TRANSIT Bus (FD_ , FB_ , FS_ , FZ_ , FC_) / TRANSIT CUSTOM Box / TRANSIT CUSTOM Bus / TRANSIT Platform/Chassis / TRANSIT Platform/Chassis (FM_ , FN_) / TRANSIT TOURNEO

PEUGEOT

BOXER Box / BOXER Bus / BOXER Platform/Chassis

A2C8139490080

**Common Rail Diesel Injector**

Diesel (V65)

Observe the vehicle manufacturer specifications (C27)

T019: Have to be taught/updated.

T024: Mandatory - check new part against old part (in particular OE No.)

FORD

RANGER (TKE)

A2C9321760080

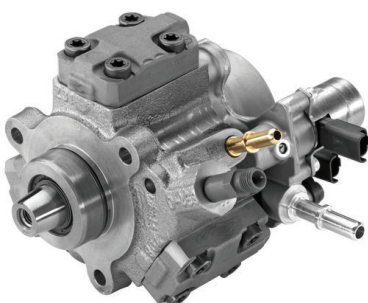
**Diesel Common Rail Pump**

Diesel (V65)

Observe the vehicle manufacturer specifications (C27)

T024: Mandatory - check new part against old part (in particular OE No.)

FORD

RANGER (TKE)



A2C9626040080



Common Rail Diesel Injector

 Diesel (V65)

Observe the vehicle manufacturer specifications (C27)

T019: Have to be taught/updated.

T024: Mandatory - check new part against old part (in particular OE No.)

AUDI

A1 (8X1, 8XK) / A1 Sportback (8XA, 8XF) / A3 (8P1) / A3 Convertible (8P7) / A3 Sportback (8PA)

SEAT

ALTEA (5P1) / ALTEA XL (5P5, 5P8) / IBIZA IV (6J5, 6P1) / IBIZA IV SPORTCOUPE (6J1, 6P5) / IBIZA IV ST (6J8, 6P8) / LEON (1P1) / TOLEDO IV (KG3)

SKODA

FABIA II (542) / FABIA II Combi (545) / OCTAVIA II (1Z3) / OCTAVIA II Combi (1Z5) / RAPID (NH3) / ROOMSTER (5J) / ROOMSTER Praktik (5J) / SUPERB II (3T4) / SUPERB II Estate (3T5) / YETI (5L)

VW

BEETLE (5C1, 5C2) / BEETLE Convertible (5C7, 5C8) / CADDY III Box (2KA, 2KH, 2CA, 2CH) / CADDY III Estate (2KB, 2KJ, 2CB, 2CJ) / CADDY IV Box (SAA, SAH) / CADDY IV Estate (SAB, SAJ) / GOLF VI (5K1) / GOLF VI Convertible (517) / GOLF VI Variant (AJ5) / GOLF PLUS (5M1, 521) / JETTA III (1K2) / JETTA IV (162, 163, AV3, AV2) / PASSAT (3C2) / PASSAT (362) / PASSAT Variant (3C5) / PASSAT Variant (365) / POLO (6R1, 6C1) / TOURAN (1T3)





Manufacturer Index

Herstellerverzeichnis

Les fabricants

Directorio de fabricantes

Elenco produttori

Каталог марок и моделей



A			
AUDI	28	FOCUS III	37
A1 (8X1, 8XK)	28	FOCUS III Saloon	38
A1 Sportback (8XA, 8XF)	28	FOCUS III Turnier	38
A3 (8P1)	28	FOCUS II Saloon (DB_, FCH, DH)	37
A3 Convertible (8P7)	28	FOCUS II Turnier (DA_, FFS, DS)	37
A3 Sportback (8PA)	28	FOCUS IV (HN)	38
C		FOCUS IV Turnier (HP)	38
CITROËN	28	FOCUS Saloon (DFW)	38
BERLINGO / BERLINGO FIRST Box (M_)	28	FOCUS Turnier (DNW)	39
BERLINGO / BERLINGO FIRST MPV (MF, GJK, GFK)	28	FUSION (JU_)	39
BERLINGO (B9)	29	GALAXY (CK)	39
BERLINGO Box (B9)	29	GALAXY (WM)	39
BERLINGO Platform/Chassis (B9)	29	GRAND C-MAX (DXA/CB7, DXA/CEU)	39
C2 (JM_)	29	KUGA I	40
C2 ENTERPRISE (JG_)	29	MONDEO IV (BA7)	40
C3 I (FC_, FN_)	29	MONDEO IV Saloon (BA7)	40
C3 II (SC_)	29	MONDEO IV Turnier (BA7)	41
C3 Picasso	29	RANGER (TKE)	41
C3 Pluriel (HB_)	30	S-MAX (CJ)	42
C4 AIRCROSS	30	S-MAX (WS)	42
C4 Coupe (LA_)	30	TOURNEO CONNECT	42
C4 Grand Picasso I (JA_)	30	TOURNEO CUSTOM Bus	43
C4 I (LC_)	30	TRANSIT Box	43
C4 II (B7)	30	TRANSIT Box (FA_ _)	44
C4 Picasso II	31	TRANSIT Bus	45
C4 Picasso I MPV (JD_)	31	TRANSIT Bus (FD_ _, FB_ _, FS_ _, FZ_ _, FC_ _)	45
C5 I (DC_)	31	TRANSIT CONNECT (P65_, P70_, P80_)	46
C5 I Break (DE_)	31	TRANSIT CUSTOM Box	46
C5 II (RC_)	31	TRANSIT CUSTOM Bus	47
C5 II Break (RE_)	31	TRANSIT Platform/Chassis	47
C5 III (RD_)	31	TRANSIT Platform/Chassis (FM_ _, FN_ _)	47
C5 III Break (RW_)	32	TRANSIT TOURNEO	48
C6 (TD_)	32	J	
C8 (EA_, EB_)	32	JAGUAR	48
DS3	32	S-TYPE (X200)	49
DS4	32	XF (X250)	49
DS5	33	L	
JUMPER Box	33	LAND ROVER	49
JUMPER Bus	33	DEFENDER Cabrio (L316)	49
JUMPER Platform/Chassis	33	DEFENDER Pickup (L316)	49
JUMPY (VF7)	33	DEFENDER Platform/Chassis (L316)	49
JUMPY Box	34	DEFENDER Station Wagon (L316)	49
XSARA (N1)	34	DISCOVERY III (L319)	49
XSARA Break (N2)	34	DISCOVERY IV (L319)	49
XSARA Coupe (N0)	34	RANGE ROVER III (L322)	50
D		RANGE ROVER SPORT (L320)	50
DAZIA	34	M	
DUSTER	34	MAZDA	50
DUSTER Box	34	3 (BL)	50
LODGY (JS_)	34	3 Saloon (BL)	50
F		5 (CW)	50
FIAT	34	MERCEDES-BENZ	50
SCUDO (270_, 272_)	35	A-CLASS (W176)	51
SCUDO Box (270_, 272_)	35	B-CLASS (W246, W242)	51
SCUDO Platform/Chassis (270_, 272_)	35	CITAN Box (415)	51
ULYSSE (179_)	35	CITAN Combi (415)	51
FORD	35	CITAN Mixto (415)	51
C-MAX (DM2)	35	CLA Coupe (C117)	51
C-MAX II (DXA/CB7, DXA/CEU)	36	CLA Shooting Brake (X117)	51
FIESTA V (JH_, JD_)	36	GLA-CLASS (X156)	51
FIESTA VI (CB1, CCN)	36	N	
FIESTA VI Van	36	NISSAN	52
FIESTA V Van	36	CUBE (Z12)	52
FOCUS (DAW, DBW)	36	JUKE (F15)	52
FOCUS C-MAX (DM2)	38	NOTE (E11, NE11)	52
FOCUS II (DA_, HCP, DP)	36	NV200 / EVALIA Bus	52
FOCUS II Convertible	37	NV200 Box Body / Estate	52
		QASHQAI / QASHQAI +2 I (J10, NJ10)	52
		QASHQAI II Closed Off-Road Vehicle (J11, J11_)	52
		TIIDA Hatchback (C11)	53
		TIIDA Saloon (SC11)	53
		P	
		PEUGEOT	53
		1007 (KM_)	57
		107	53
		2008 (CU_)	57
		207 CC (WD_)	53
		207 SW (WK_)	53
		208 (CA_, CC_)	53
		3008 MPV (OU_)	57
		307 (3A/C)	53
		307 Break (3E)	54
		307 CC (3B)	54
		307 SW (3H)	54
		308 (4A_, 4C_)	54
		308 CC (4B_)	55
		308 II	54
		308 SW (4E_, 4H_)	55
		4008	57
		406 (8B)	55
		406 Break (8E/F)	55
		407 (6D_)	55
		407 Coupe (6C_)	56
		407 SW (6E_)	56
		5008 (OU_, OE_)	57
		508 I (8D_)	56
		508 SW I (8E_)	56
		607 (9D, 9U)	56
		807 (E)	57
		BOXER Box	58
		BOXER Bus	58
		BOXER Platform/Chassis	58
		EXPERT Box (VF3A_, VF3U_, VF3X_)	58
		EXPERT Platform/Chassis	58
		EXPERT Tepee (VF3X_)	59
		PARTNER Box	59
		PARTNER Box (5)	59
		PARTNER Combispace (5F)	59
		PARTNER Tepee	59
		R	
		RENAULT	59
		CAPTUR (J5_, H5_)	59
		CLIO Grandtour (KR0/1_)	60
		CLIO III (BR0/1, CR0/1)	60
		FLUENCE (L3_)	60
		GRAND SCÉNIC III (JZ0/1_)	60
		KADJAR (HA_, HL_)	60
		KANGOO / GRAND KANGOO (KW0/1_)	61
		KANGOO BE BOP (KW0/1_)	61
		KANGOO Express (FW0/1_)	61
		LAGUNA Coupe (DT0/1)	61
		LAGUNA III (BT0/1)	61
		LAGUNA III Grandtour (KT0/1)	61
		LATITUDE (L70_)	61
		MEGANE CC (EZ0/1_)	63
		MEGANE II (BMO/1_, CM0/1_)	62
		MEGANE II Coupé-Cabriolet (EM0/1_)	62
		MEGANE II Estate (KMO/1_)	62
		MEGANE III Coupe (DZ0/1_)	62
		MEGANE III Grandtour (KZ0/1)	62
		MEGANE III Hatchback (BZ0/1_)	63
		MEGANE II Saloon (LMO/1_)	62
		MODUS / GRAND MODUS (F/J/P0_)	63
		SCÉNIC II (JM0/1_)	63
		SCÉNIC III (JZ0/1_)	63
		S	



SEAT	63
ALTEA (5P1)	63
ALTEA XL (5P5, 5P8)	64
IBIZA IV (6J5, 6P1)	64
IBIZA IV SPORTCOUPE (6J1, 6P5)	64
IBIZA IV ST (6J8, 6P8)	64
LEON (1P1)	64
TOLEDO IV (KG3)	64
SKODA	64
FABIA II (542)	64
FABIA II Combi (545)	65
OCTAVIA II (1Z3)	65
OCTAVIA II Combi (1Z5)	65
RAPID (NH3)	65
RAPID Spaceback (NH1)	65
ROOMSTER (5J)	65
ROOMSTER Praktik (5J)	65
SUPERB II (3T4)	66
SUPERB II Estate (3T5)	66
YETI (5L)	66
T	
TOYOTA	66
AYGO (B1_)	66
V	
VOLVO	66
C30 (533)	66
C70 II Convertible (542)	66
S40 II (544)	66
S60 II (134)	66
S80 II (124)	67
V40 Hatchback (525, 526)	67
V50 (545)	67
V60 (155, 157)	67
V70 III (135)	67
VW	67
BEETLE (5C1, 5C2)	67
BEETLE Convertible (5C7, 5C8)	67
CADDY III Box (2KA, 2KH, 2CA, 2CH)	68
CADDY III Estate (2KB, 2KJ, 2CB, 2CJ)	68
CADDY IV Box (SAA, SAH)	68
CADDY IV Estate (SAB, SAJ)	68
GOLF PLUS (5M1, 521)	69
GOLF VI (5K1)	68
GOLF VI Convertible (517)	68
GOLF VI Variant (AJ5)	69
JETTA III (1K2)	69
JETTA IV (162, 163, AV3, AV2)	69
PASSAT (362)	69
PASSAT (3C2)	69
PASSAT Variant (365)	70
PASSAT Variant (3C5)	69
POLO (6R1, 6C1)	70
TOURAN (1T3)	70

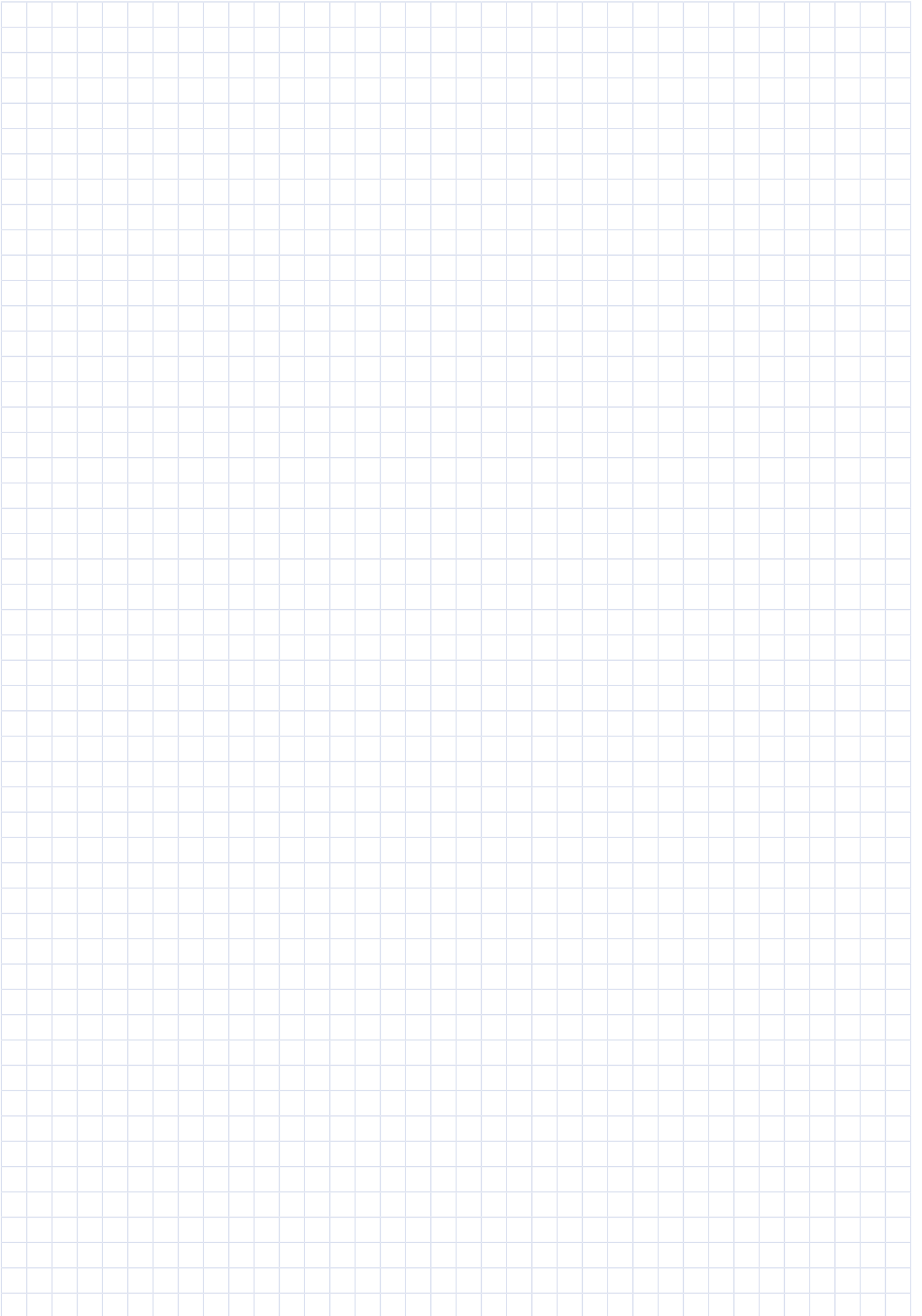



Product Application

Produktverwendungen

Utilisations du produit

Aplicaciones el producto

Usi del prodotto

Подбор по автомобилю



VDO

**AUDI - A1 (8X1, 8XK) 05/10→10/18****Common Rail Diesel Injector**

1.6 TDI	66 kW	03/11→04/15	CAYB	A2C9626040080	22
1.6 TDI	77 kW	05/10→04/15	CAYC	A2C9626040080	22

**Diesel Common Rail Pump**

1.6 TDI	66 kW	03/11→04/15	CAYB	A2C59517049	21
1.6 TDI	77 kW	05/10→04/15	CAYC	A2C59517047	20
			CAYC; 05/11 ; Model year to (C21): 2012; for OE number (C61): 03L 906 023KP / 03L 906 023 KQ	A2C59517049	21

AUDI - A1 Sportback (8XA, 8XF) 09/11→10/18**Common Rail Diesel Injector**

1.6 TDI	66 kW	11/11→04/15	CAYB	A2C9626040080	22
---------	-------	-------------	------	----------------------	----

**Diesel Common Rail Pump**

1.6 TDI	66 kW	11/11→04/15	CAYB	A2C59517049	21
1.6 TDI	77 kW	11/11→04/15	CAYC	A2C59517047	20
			CAYC; Model year to (C21): 2012; for OE number (C61): 03L 906 023 KP / 03L 906 023 KQ	A2C59517049	21

AUDI - A3 (8P1) 05/03→12/13**Common Rail Diesel Injector**

1.6 TDI	66 kW	05/09→08/12	CAYB	A2C9626040080	22
1.6 TDI	77 kW	05/09→08/12	CAYC	A2C9626040080	22

**Diesel Common Rail Pump**

1.6 TDI	66 kW	05/09→08/12	CAYB	A2C59517047	20
1.6 TDI	77 kW	05/09→08/12	CAYC	A2C59517047	20

AUDI - A3 Convertible (8P7) 04/08→05/13**Common Rail Diesel Injector**

1.6 TDI	77 kW	05/09→05/13	CAYC	A2C9626040080	22
---------	-------	-------------	------	----------------------	----

**Diesel Common Rail Pump**

1.6 TDI	77 kW	05/09→05/13	CAYC	A2C59517047	20
---------	-------	-------------	------	--------------------	----

AUDI - A3 Sportback (8PA) 09/04→12/15**Common Rail Diesel Injector**

1.6 TDI	66 kW	05/09→03/13	CAYB	A2C9626040080	22
1.6 TDI	77 kW	05/09→03/13	CAYC	A2C9626040080	22

**Diesel Common Rail Pump**

1.6 TDI	66 kW	05/09→03/13	CAYB	A2C59517047	20
1.6 TDI	77 kW	05/09→03/13	CAYC	A2C59517047	20

CITROËN - BERLINGO / BERLINGO FIRST Box (M_) 07/96→12/11**Common Rail Diesel Injector**

2.0 HDI 90 (MBRHY, MCRHY)	66 kW	12/99→12/11	RHY (DW10TD)	5WS40000-Z	8
---------------------------	-------	-------------	--------------	-------------------	---

**Diesel Common Rail Pump**

2.0 HDI 90 (MBRHY, MCRHY)	66 kW	12/99→12/11	RHY (DW10TD)	5WS40018-Z	8
---------------------------	-------	-------------	--------------	-------------------	---

CITROËN - BERLINGO / BERLINGO FIRST MPV (MF, GJK, GFK) 07/96→12/11**Common Rail Diesel Injector**

2.0 HDI 90 (MFRHY)	66 kW	12/99→10/05	RHY (DW10TD)	5WS40000-Z	8
--------------------	-------	-------------	--------------	-------------------	---

**Diesel Common Rail Pump**

2.0 HDI 90 (MFRHY)	66 kW	12/99→10/05	RHY (DW10TD)	5WS40018-Z	8
--------------------	-------	-------------	--------------	-------------------	---



VDO

CITROËN - BERLINGO (B9) 04/08→

Common Rail Diesel Injector

1.6 HDi 110	82 kW	07/10→	9HR (DV6C); 12/11	A2C59513556	18
			9HR (DV6C); 12/11	A2C59513556	18
1.6 HDi 115	84 kW	07/10→	9HR (DV6C); 12/11	A2C59513556	18

Diesel Common Rail Pump

1.6 HDi 110	82 kW	07/10→	9HR (DV6C)	A2C59513830	19
1.6 HDi 115	84 kW	07/10→			

CITROËN - BERLINGO Box (B9) 04/08→

Common Rail Diesel Injector

1.6 HDi 110	82 kW	07/10→	9HR (DV6C); 12/11	A2C59513556	18
			9HR (DV6C); 12/11	A2C59513556	18
1.6 HDi 115	84 kW	07/10→	9HL (DV6C); 12/11	A2C59513556	18

Diesel Common Rail Pump

1.6 HDi 110	82 kW	07/10→	9HR (DV6C)	A2C59513830	19
1.6 HDi 115	84 kW	07/10→	9HL (DV6C)	A2C59513830	19

CITROËN - BERLINGO Platform/Chassis (B9) 04/08→

Common Rail Diesel Injector

1.6 HDi 90 16V	66 kW	04/08→	12/11	A2C59513556	18
			12/11	A2C59513556	18
			03/10 12/11	A2C59513556	18

Diesel Common Rail Pump

1.6 HDi 90 16V	66 kW	04/08→	07/10	A2C59513830	19
----------------	-------	--------	-------	-------------	----

CITROËN - C2 (JM_) 09/03→

Common Rail Diesel Injector

1.4 HDi	50 kW	09/03→	8HX (DV4TD)	A2C59511612	16
---------	-------	--------	-------------	-------------	----

CITROËN - C2 ENTERPRISE (JG_) 11/03→

Common Rail Diesel Injector

1.4 HDi	50 kW	04/09→	8HX (DV4TD)	A2C59511612	16
---------	-------	--------	-------------	-------------	----

CITROËN - C3 I (FC_, FN_) 02/02→

Common Rail Diesel Injector

1.4 HDi	50 kW	02/02→	8HX (DV4TD)	A2C59511612	16
---------	-------	--------	-------------	-------------	----

CITROËN - C3 II (SC_) 11/09→

Common Rail Diesel Injector

1.4 HDi 70	50 kW	11/09→	8HZ (DV4TD)	A2C59511612	16
1.6 HDi 110	82 kW	11/09→	9HR (DV6C); 12/11	A2C59513556	18
			9HR (DV6C); 12/11	A2C59513556	18
			9HR (DV6C); 03/10 12/11	A2C59513556	18
1.6 HDi 115	84 kW	09/12→		A2C59513556	18

Diesel Common Rail Pump

1.6 HDi 110	82 kW	11/09→	9HR (DV6C); 07/10	A2C59513830	19
			9HR (DV6C); 06/10	A2C59513830	19
1.6 HDi 115	84 kW	09/12→		A2C59513830	19

CITROËN - C3 Picasso 02/09→

Common Rail Diesel Injector

1.6 HDi 110	82 kW	05/10→	9HR (DV6C); 12/11	A2C59513556	18
			9HR (DV6C); 12/11	A2C59513556	18
1.6 HDi 115	84 kW	01/13→	9HL (DV6C)	A2C59513556	18



VDO

**CITROËN - C3 Picasso 02/09→****Diesel Common Rail Pump**

1.6 HDi 110	82 kW	05/10→	9HR (DV6C); 07/10	A2C59513830	19
1.6 HDi 115	84 kW	01/13→	9HR (DV6C); 06/10	A2C59513830	19
			9HL (DV6C)	A2C59513830	19

CITROËN - C3 Pluriel (HB_) 05/03→**Common Rail Diesel Injector**

1.4 HDi	50 kW	04/04→	8HX (DV4TD)	5WS40148-Z	8
---------	-------	--------	-------------	-------------------	---

CITROËN - C4 I (LC_) 11/04→12/13**Common Rail Diesel Injector**

2.0 HDi	100 kW	11/04→07/11	RHR (DW10BTED4)	A2C59511603	14
2.0 HDi	103 kW	07/08→07/11	RHF (DW10BTED4); Version (C2): Class 4	5WS40156-4Z	9
				5WS40156-Z	9
			RHF (DW10BTED4); Version (C2): Class 6	A2C59511601	14
			RHF (DW10BTED4); Version (C2): Class M	A2C59511603	14

CITROËN - C4 II (B7) 02/09→**Common Rail Diesel Injector**

1.6 HDi 110	82 kW	11/09→	9HR (DV6C); 12/11	A2C59513556	18
			9HR (DV6C); 12/11	A2C59513556	18
			9HR (DV6C); 03/10 12/11	A2C59513556	18
1.6 HDi 115	84 kW	07/12→	9HR (DV6C)	A2C59513556	18

**Diesel Common Rail Pump**

1.6 HDi 110	82 kW	11/09→	9HR (DV6C); 07/10	A2C59513830	19
1.6 HDi 115	84 kW	07/12→	9HR (DV6C)	A2C59513830	19

CITROËN - C4 AIRCROSS 08/10→**Common Rail Diesel Injector**

1.6 HDi 115	84 kW	04/12→	9HL (DV6C)	A2C59513556	18
1.6 HDi 115 AWC	84 kW	05/12→			

**Diesel Common Rail Pump**

1.6 HDi 115	84 kW	04/12→	9HL (DV6C)	A2C59513830	19
1.6 HDi 115 AWC	84 kW	05/12→			

CITROËN - C4 Coupe (LA_) 11/04→12/13**Common Rail Diesel Injector**

2.0 HDi	100 kW	11/04→12/10	RHR (DW10BTED4)	A2C59511603	14
2.0 HDi	103 kW	07/08→07/11	RHF (DW10BTED4); Version (C2): Class 4	5WS40156-4Z	9
				5WS40156-Z	9
			RHF (DW10BTED4); Version (C2): Class 6	A2C59511601	14
			RHF (DW10BTED4); Version (C2): Class M	A2C59511603	14

CITROËN - C4 Grand Picasso I (UA_) 10/06→12/13**Common Rail Diesel Injector**

1.6 HDi 110	82 kW	09/10→08/13	9HR (DV6C); 12/11	A2C59513556	18
			9HR (DV6C); 12/11	A2C59513556	18
2.0 HDi 138	100 kW	10/06→12/13	RHJ (DW10BTED4) / RHR (DW10BTED4)	A2C59511603	14

**Diesel Common Rail Pump**

1.6 HDi 110	82 kW	09/10→08/13	9HR (DV6C)	A2C59513830	19
2.0 HDi 138	100 kW	10/06→12/13	RHJ (DW10BTED4)	5WS40809-Z	10
			RHR (DW10BTED4)	5WS40809-Z	10



VDO

CITROËN - C4 Picasso I MPV (UD_) 10/06→12/15

Common Rail Diesel Injector

1.6 HDi 110	82 kW	09/10→08/13	9HR (DV6C); 12/11	A2C59513556	18
			9HR (DV6C); 12/11	A2C59513556	18
2.0 HDi 138	100 kW	10/06→08/13	RHJ (DW10BTED4) / RHR (DW10BTED4)	A2C59511603	14

Diesel Common Rail Pump

1.6 HDi 110	82 kW	09/10→08/13	9HR (DV6C)	A2C59513830	19
2.0 HDi 138	100 kW	10/06→08/13	RHJ (DW10BTED4)	5WS40809-Z	10
			RHR (DW10BTED4)	5WS40809-Z	10

CITROËN - C4 Picasso II 01/13→

Common Rail Diesel Injector

1.6 HDi / BlueHDi 115	85 kW	02/13→		A2C59513556	18
-----------------------	-------	--------	--	--------------------	----

Diesel Common Rail Pump

1.6 HDi / BlueHDi 115	85 kW	02/13→		A2C59513830	19
-----------------------	-------	--------	--	--------------------	----

CITROËN - C5 I (DC_) 03/01→03/05

Common Rail Diesel Injector

2.0 HDi (DCRHYB)	66 kW	03/01→08/04	RHY (DW10TD)	5WS40000-Z	8
------------------	-------	-------------	--------------	-------------------	---

Diesel Common Rail Pump

2.0 HDi (DCRHYB)	66 kW	03/01→08/04	RHY (DW10TD)	5WS40018-Z	8
------------------	-------	-------------	--------------	-------------------	---

CITROËN - C5 I Break (DE_) 06/01→09/04

Common Rail Diesel Injector

2.0 HDi (DERHYB)	66 kW	06/01→08/04	RHY (DW10TD)	5WS40000-Z	8
------------------	-------	-------------	--------------	-------------------	---

Diesel Common Rail Pump

2.0 HDi (DERHYB)	66 kW	06/01→08/04	RHY (DW10TD)	5WS40018-Z	8
------------------	-------	-------------	--------------	-------------------	---

CITROËN - C5 II (RC_) 08/04→

Common Rail Diesel Injector

2.0 HDi (RCRHRH)	100 kW	09/04→	RHR (DW10BTED4); Version (C2): Class 4	5WS40156-4Z	9
				5WS40156-Z	9
			RHR (DW10BTED4); Version (C2): Class 6	A2C59511601	14

Diesel Common Rail Pump

2.0 HDi (RCRHRH)	100 kW	09/04→		5WS40809-Z	10
------------------	--------	--------	--	-------------------	----

CITROËN - C5 II Break (RE_) 09/04→

Common Rail Diesel Injector

2.0 HDi (RERHRH)	100 kW	09/04→	RHR (DW10BTED4); Version (C2): Class 4	5WS40156-4Z	9
				5WS40156-Z	9
			RHR (DW10BTED4); Version (C2): Class 6	A2C59511601	14

Diesel Common Rail Pump

2.0 HDi (RERHRH)	100 kW	09/04→		5WS40809-Z	10
------------------	--------	--------	--	-------------------	----

CITROËN - C5 III (RD_) 02/08→

Common Rail Diesel Injector

1.6 HDi 110	82 kW	07/10→	9HR (DV6C); 12/11	A2C59513556	18
			9HR (DV6C); 12/11	A2C59513556	18
1.6 HDi 115	84 kW	01/12→	9HR (DV6C)	A2C59513556	18
2.7 HDi	150 kW	02/08→	DT17ED4	A2C59511316	12

Diesel Common Rail Pump

1.6 HDi 110	82 kW	07/10→	9HR (DV6C)	A2C59513830	19
1.6 HDi 115	84 kW	01/12→			



VDO

**CITROËN - C5 III (RD_) 02/08→****Distributor Pipe, fuel**

2.7 HDi	150 kW	02/08→	DT17ED4; ↕ Fuel Rail (V240)	A2C59511317	12
			DT17ED4; ↕	A2C59511318	12
			DT17ED4; ↕	A2C59511319	13

CITROËN - C5 III Break (RW_) 02/08→ **Common Rail Diesel Injector**

1.6 HDi 110	82 kW	07/10→	9HR (DV6C); 12/11	A2C59513556	18
			9HR (DV6C); 12/11	A2C59513556	18
1.6 HDi 115	84 kW	01/12→	9HR (DV6C)	A2C59513556	18
2.7 HDi	150 kW	02/08→	UHZ (DT17BTED4)	A2C59511316	12
			DT17ED4	A2C59511316	12

Diesel Common Rail Pump

1.6 HDi 110	82 kW	07/10→	9HR (DV6C)	A2C59513830	19
1.6 HDi 115	84 kW	01/12→			

Distributor Pipe, fuel

2.7 HDi	150 kW	02/08→	UHZ (DT17BTED4); ↕ Fuel Rail (V240)	A2C59511317	12
			DT17ED4; ↕ Fuel Rail (V240)	A2C59511317	12
			DT17ED4; ↕	A2C59511318	12
			UHZ (DT17BTED4); ↕	A2C59511318	12
			UHZ (DT17BTED4); ↕	A2C59511319	13
			DT17ED4; ↕	A2C59511319	13

CITROËN - C6 (TD_) 09/05→12/12 **Common Rail Diesel Injector**

2.7 HDi	150 kW	09/05→12/11	UHZ (DT17BTED4)	A2C59511316	12
			DT17ED4	A2C59511316	12

Distributor Pipe, fuel

2.7 HDi	150 kW	09/05→12/11	UHZ (DT17BTED4); ↕ Fuel Rail (V240)	A2C59511317	12
			DT17ED4; ↕ Fuel Rail (V240)	A2C59511317	12
			DT17ED4; ↕	A2C59511318	12
			UHZ (DT17BTED4); ↕	A2C59511318	12
			UHZ (DT17BTED4); ↕	A2C59511319	13
			DT17ED4; ↕	A2C59511319	13

CITROËN - C8 (EA_, EB_) 06/02→ **Common Rail Diesel Injector**

2.0 HDi	88 kW	07/06→		A2C59511602	14
---------	-------	--------	--	--------------------	----

Diesel Common Rail Pump

2.0 HDi	88 kW	07/06→		5WS40809-Z	10
---------	-------	--------	--	-------------------	----

CITROËN - DS3 11/09→07/15 **Common Rail Diesel Injector**

1.6 HDi 110	82 kW	11/09→07/15	9HR (DV6C); 12/11	A2C59513556	18
			9HR (DV6C); 12/11	A2C59513556	18
			9HR (DV6C); 03/10 12/11	A2C59513556	18
			9HR (DV6C); 03/10	A2C59513556	18
1.6 HDi 115	84 kW	08/12→07/15	9HL (DV6C)	A2C59513556	18

Diesel Common Rail Pump

1.6 HDi 110	82 kW	11/09→07/15	9HR (DV6C); 07/10	A2C59513830	19
			9HR (DV6C); 06/10	A2C59513830	19
1.6 HDi 115	84 kW	08/12→07/15	9HL (DV6C)	A2C59513830	19

CITROËN - DS4 03/11→07/15 **Common Rail Diesel Injector**

1.6 HDi 110	82 kW	04/11→07/15	9HR (DV6C); 12/11	A2C59513556	18
			9HR (DV6C); 12/11	A2C59513556	18



VDO



CITROËN - DS4 03/11→07/15



Common Rail Diesel Injector

1.6 HDi 115	84 kW	08/12→07/15	9HL (DV6C)	A2C59513556	18
-------------	-------	-------------	------------	-------------	----



Diesel Common Rail Pump

1.6 HDi 110	82 kW	04/11→07/15	9HR (DV6C)	A2C59513830	19
1.6 HDi 115	84 kW	08/12→07/15	9HL (DV6C)	A2C59513830	19

CITROËN - DS5 09/11→07/15



Common Rail Diesel Injector

1.6 HDi 110	82 kW	11/11→07/15	9HR (DV6C); 12/11	A2C59513556	18
			9HR (DV6C); 12/11	A2C59513556	18
1.6 HDi 115	84 kW	06/12→07/15		A2C59513556	18



Diesel Common Rail Pump

1.6 HDi 110	82 kW	11/11→07/15	9HR (DV6C)	A2C59513830	19
1.6 HDi 115	84 kW	06/12→07/15		A2C59513830	19

CITROËN - JUMPER Box 04/06→



Common Rail Diesel Injector

2.0 BlueHDi 110	81 kW	04/16→	AHM (DW10FUE)	A2C59517051	21
2.0 BlueHDi 130	96 kW	04/16→	AHN (DW10FUD)	A2C59517051	21
2.2 HDi 110	81 kW	07/11→		A2C59517051	21
2.2 HDi 130	96 kW	07/11→			
2.2 HDi 150	110 kW	07/11→			



Diesel Common Rail Pump

2.2 HDi 110	81 kW	07/11→		A2C59517045	20
2.2 HDi 130	96 kW	07/11→			
2.2 HDi 150	110 kW	07/11→			

CITROËN - JUMPER Bus 04/06→



Common Rail Diesel Injector

2.0 BlueHDi 110	81 kW	07/15→		A2C59517051	21
2.2 HDi 110	81 kW	07/11→			
2.2 HDi 130	96 kW	07/11→			
2.2 HDi 150	110 kW	07/11→			



Diesel Common Rail Pump

2.2 HDi 110	81 kW	07/11→		A2C59517045	20
2.2 HDi 130	96 kW	07/11→			
2.2 HDi 150	110 kW	07/11→			

CITROËN - JUMPER Platform/Chassis 04/06→



Common Rail Diesel Injector

2.0 BlueHDi 110	81 kW	04/16→	AHM (DW10FUE)	A2C59517051	21
2.0 BlueHDi 130	96 kW	04/16→	AHN (DW10FUD)	A2C59517051	21
2.0 BlueHDi 130 4x4	96 kW	04/16→			
2.2 HDi 110	81 kW	07/11→		A2C59517051	21
2.2 HDi 130	96 kW	07/11→			
2.2 HDi 150	110 kW	07/11→			



Diesel Common Rail Pump

2.2 HDi 110	81 kW	07/11→		A2C59517045	20
2.2 HDi 130	96 kW	07/11→			
2.2 HDi 150	110 kW	07/11→			

CITROËN - JUMPY (VF7) 01/07→



Common Rail Diesel Injector

2.0 HDi 120	88 kW	01/07→		A2C59511602	14
-------------	-------	--------	--	-------------	----



Diesel Common Rail Pump

2.0 HDi 120	88 kW	01/07→		5WS40809-Z	10
-------------	-------	--------	--	------------	----



				VDO	
CITROËN - JUMPY Box 01/07→					
Common Rail Diesel Injector					
2.0 HDi 120	88 kW	01/07→		A2C59511602	14
Diesel Common Rail Pump					
2.0 HDi 120	88 kW	01/07→		5WS40809-Z	10
CITROËN - XSARA (N1) 04/97→12/05					
Common Rail Diesel Injector					
2.0 HDi 90	66 kW	02/99→03/05	RHY (DW10TD)	5WS40000-Z	8
Diesel Common Rail Pump					
2.0 HDi 90	66 kW	02/99→03/05	RHY (DW10TD)	5WS40018-Z	8
CITROËN - XSARA Break (N2) 10/97→03/10					
Common Rail Diesel Injector					
2.0 HDi 90	66 kW	02/99→08/05	RHY (DW10TD)	5WS40000-Z	8
Diesel Common Rail Pump					
2.0 HDi 90	66 kW	02/99→08/05	RHY (DW10TD)	5WS40018-Z	8
CITROËN - XSARA Coupe (N0) 01/98→04/05					
Common Rail Diesel Injector					
2.0 HDi 90	66 kW	02/99→03/05	RHY (DW10TD)	5WS40000-Z	8
Diesel Common Rail Pump					
2.0 HDi 90	66 kW	02/99→03/05	RHY (DW10TD)	5WS40018-Z	8
DACIA - DUSTER 04/10→					
Common Rail Diesel Injector					
1.5 dCi	79 kW	06/10→	K9K 896	A2C59513484	17
1.5 dCi	80 kW	08/13→	K9K 856	A2C59513484	17
1.5 dCi 4x4	80 kW	08/13→	K9K 858	A2C59513484	17
1.5 dCi 4x4	81 kW	10/10→	K9K 898	A2C59513484	17
Diesel Common Rail Pump					
1.5 dCi	79 kW	06/10→	K9K 896	A2C59513595	18
1.5 dCi	80 kW	08/13→	K9K 856	A2C59513595	18
1.5 dCi 4x4	80 kW	08/13→	K9K 858	A2C59513595	18
1.5 dCi 4x4	81 kW	10/10→	K9K 898	A2C59513595	18
DACIA - DUSTER Box 04/11→					
Common Rail Diesel Injector					
1.5 dCi	80 kW	04/13→	K9K 856	A2C59513484	17
1.5 dCi 4x4	80 kW	04/13→	K9K 858	A2C59513484	17
Diesel Common Rail Pump					
1.5 dCi	80 kW	04/13→	K9K 856	A2C59513595	18
1.5 dCi 4x4	80 kW	04/13→	K9K 858	A2C59513595	18
DACIA - LODGY (JS_) 03/12→					
Common Rail Diesel Injector					
1.5 dCi	79 kW	01/13→	K9K 846	A2C59513484	17
Diesel Common Rail Pump					
1.5 dCi	79 kW	01/13→	K9K 846	A2C59513595	18



VDO

FIAT - SCUDO (270_, 272_) 01/07→

Common Rail Diesel Injector

2.0 D Multijet	88 kW	01/07→	RHK; Version (C2): Class 4	5WS40156-4Z	9
			RHK	A2C59511602	14
2.0 D Multijet	100 kW	01/07→	RHR; Version (C2): Class 4	5WS40156-4Z	9
			RHR; Version (C2): Class 5	5WS40156-Z	9
			RHR; Version (C2): Class 6	A2C59511601	14
2.0 D Multijet 4x4	88 kW	01/07→	RHK; Version (C2): Class 4	5WS40156-4Z	9
			RHK	A2C59511602	14

Diesel Common Rail Pump

2.0 D Multijet	88 kW	01/07→	RHK	5WS40809-Z	10
2.0 D Multijet	100 kW	01/07→	RHR	5WS40809-Z	10
2.0 D Multijet 4x4	88 kW	01/07→	RHK	5WS40809-Z	10

FIAT - SCUDO Box (270_, 272_) 01/07→

Common Rail Diesel Injector

2.0 D Multijet	88 kW	01/07→	RHK; Version (C2): Class 4	5WS40156-4Z	9
			RHK	A2C59511602	14
2.0 D Multijet	100 kW	01/07→	RHR; Version (C2): Class 4	5WS40156-4Z	9
			RHR; Version (C2): Class 5	5WS40156-Z	9
			RHR; Version (C2): Class 6	A2C59511601	14
2.0 D Multijet 4x4	88 kW	01/07→	RHK; Version (C2): Class 4	5WS40156-4Z	9
			RHK	A2C59511602	14

Diesel Common Rail Pump

2.0 D Multijet	88 kW	01/07→	RHK	5WS40809-Z	10
2.0 D Multijet	100 kW	01/07→	RHR	5WS40809-Z	10
2.0 D Multijet 4x4	88 kW	01/07→	RHK	5WS40809-Z	10

FIAT - SCUDO Platform/Chassis (270_, 272_) 01/07→

Common Rail Diesel Injector

2.0 D Multijet	88 kW	01/07→	RHK; Version (C2): Class 4	5WS40156-4Z	9
			RHK	A2C59511602	14
2.0 D Multijet	100 kW	01/07→	RHR / DW10BTED4; Version (C2): Class 4	5WS40156-4Z	9
			RHR	5WS40156-Z	9
			DW10BTED4	5WS40156-Z	9
			RHR / DW10BTED4; Version (C2): Class 6	A2C59511601	14

Diesel Common Rail Pump

2.0 D Multijet	88 kW	01/07→	RHK	5WS40809-Z	10
2.0 D Multijet	100 kW	01/07→	RHR	5WS40809-Z	10
			DW10BTED4	5WS40809-Z	10

FIAT - ULYSSE (179_) 08/02→06/11

Common Rail Diesel Injector

2.0 D Multijet	88 kW	05/06→06/11	RHK; Version (C2): Class 4	5WS40156-4Z	9
			RHK	A2C59511602	14
2.0 D Multijet	100 kW	05/06→06/11	RHR; Version (C2): Class 4	5WS40156-4Z	9
			RHR; Version (C2): Class 5	5WS40156-Z	9
			RHR; Version (C2): Class 6	A2C59511601	14

Diesel Common Rail Pump

2.0 D Multijet	88 kW	05/06→06/11	RHK	5WS40809-Z	10
2.0 D Multijet	100 kW	05/06→06/11	RHR	5WS40809-Z	10

FORD - C-MAX (DM2) 02/07→09/10

Common Rail Diesel Injector

1.8 TDCi	85 kW	02/07→09/10	KKDA	A2C59511610	16
----------	-------	-------------	------	-------------	----



VDO

**FORD - C-MAX (DM2) 02/07→09/10****Common Rail Diesel Injector**

2.0 TDCi	100 kW	02/07→09/10	G6DA / G6DB / G6DD / G6DG; Version (C2): Class 4	5WS40156-4Z	9
			G6DA / G6DB / G6DD / G6DG; Version (C2): Class 5	5WS40156-Z	9
			G6DA / G6DB / G6DD / G6DG; Version (C2): Class 6	A2C59511601	14

**Diesel Common Rail Pump**

1.8 TDCi	85 kW	02/07→09/10	KKDA	A2C59511609	15
2.0 TDCi	100 kW	02/07→09/10	G6DB	A2C59511600	13
			G6DD	A2C59511600	13
			G6DG	A2C59511600	13
			G6DA	A2C59511600	13

FORD - C-MAX II (DXA/CB7, DXA/CEU) 04/10→**Common Rail Diesel Injector**

1.6 TDCi	70 kW	12/10→	T3DB	A2C59513556	18
			T3DA	A2C59513556	18
1.6 TDCi	85 kW	12/10→	T1DB	A2C59513556	18
			T1DA	A2C59513556	18

**Diesel Common Rail Pump**

1.6 TDCi	70 kW	12/10→	T3DA	A2C59513829	19
			T3DB	A2C59513829	19
1.6 TDCi	85 kW	12/10→	T1DA	A2C59513829	19
			T1DB	A2C59513829	19

FORD - FIESTA V (JH_, JD_) 11/01→03/10**Common Rail Diesel Injector**

1.4 TDCi	50 kW	11/01→06/08	F6JA	A2C59511612	16
----------	-------	-------------	------	--------------------	----

FORD - FIESTA V Van 05/02→08/08**Common Rail Diesel Injector**

1.4 TDCi	50 kW	10/03→12/10	F6JB	A2C59511612	16
----------	-------	-------------	------	--------------------	----

FORD - FIESTA VI (CB1, CCN) 06/08→**Common Rail Diesel Injector**

1.4 TDCi	50 kW	01/09→	F6JB	A2C59511612	16
----------	-------	--------	------	--------------------	----

FORD - FIESTA VI Van 08/08→**Common Rail Diesel Injector**

1.4 TDCi	50 kW	01/09→	F6JB	A2C59511612	16
----------	-------	--------	------	--------------------	----

FORD - FOCUS (DAW, DBW) 09/98→12/07**Common Rail Diesel Injector**

1.8 TDCi	74 kW	08/02→11/04	FFDA	A2C59511610	16
----------	-------	-------------	------	--------------------	----

**Diesel Common Rail Pump**

1.8 TDCi	74 kW	08/02→11/04	FFDA	A2C59511609	15
----------	-------	-------------	------	--------------------	----

FORD - FOCUS II (DA_, HCP, DP) 07/04→09/13**Common Rail Diesel Injector**

1.8 TDCi	85 kW	01/05→09/12	KKDB	A2C59511610	16
			KKDA	A2C59511610	16
2.0 TDCi	100 kW	07/04→09/12	G6DA / G6DB; Version (C2): Class 4	5WS40156-4Z	9
			G6DA / G6DB; Version (C2): Class 5	5WS40156-Z	9
			G6DA / G6DB; Version (C2): Class 6	A2C59511601	14

**Diesel Common Rail Pump**

1.8 TDCi	85 kW	01/05→09/12	KKDB	A2C59511609	15
			KKDA	A2C59511609	15



VDO

FORD - FOCUS II (DA_, HCP, DP) 07/04→09/13

Diesel Common Rail Pump

2.0 TDCi	100 kW	07/04→09/12	G6DB; 10/06	5WS40809-Z	10
			G6DA; 10/06	5WS40809-Z	10
			G6DA; 11/06 ; Specification (C3): Eurocode 223	A2C59511600	13
			G6DB; 11/06 ; Specification (C3): Eurocode 223	A2C59511600	13

FORD - FOCUS II Convertible 10/06→09/10

Common Rail Diesel Injector

2.0 TDCi	100 kW	10/06→09/10	G6DA; Version (C2): Class 4	5WS40156-4Z	9
			G6DA; Version (C2): Class 5	5WS40156-Z	9
			G6DA; Version (C2): Class 6	A2C59511601	14

Diesel Common Rail Pump

2.0 TDCi	100 kW	10/06→09/10	G6DA	5WS40809-Z	10
			G6DA; Specification (C3): Eurocode 223	A2C59511600	13

FORD - FOCUS II Saloon (DB_, FCH, DH) 04/05→

Common Rail Diesel Injector

1.8 TDCi	85 kW	04/05→09/12	KKDB	A2C59511610	16
			KKDA	A2C59511610	16
2.0 TDCi	100 kW	04/05→09/12	G6DB; Version (C2): Class 4	5WS40156-4Z	9
			G6DB; Version (C2): Class 5	5WS40156-Z	9
			G6DB; Version (C2): Class 6	A2C59511601	14

Diesel Common Rail Pump

1.8 TDCi	85 kW	04/05→09/12	KKDB	A2C59511609	15
			KKDA	A2C59511609	15
2.0 TDCi	100 kW	04/05→09/12	G6DB; 10/06	5WS40809-Z	10
			G6DB; 11/06 ; Specification (C3): Eurocode 223	A2C59511600	13

FORD - FOCUS II Turnier (DA_, FFS, DS) 07/04→09/12

Common Rail Diesel Injector

1.8 TDCi	85 kW	07/04→09/12	KKDB	A2C59511610	16
			KKDA	A2C59511610	16
2.0 TDCi	100 kW	07/04→09/12	G6DA / G6DB; Version (C2): Class 4	5WS40156-4Z	9
			G6DA / G6DB; Version (C2): Class 5	5WS40156-Z	9
			G6DA	A2C59511601	14

Diesel Common Rail Pump

1.8 TDCi	85 kW	07/04→09/12	KKDB	A2C59511609	15
			KKDA	A2C59511609	15
2.0 TDCi	100 kW	07/04→09/12	G6DB; 10/06	5WS40809-Z	10
			G6DA; 10/06	5WS40809-Z	10
			G6DA; 11/06 ; Specification (C3): Eurocode 223	A2C59511600	13
			G6DB; 11/06 ; Specification (C3): Eurocode 223	A2C59511600	13

FORD - FOCUS III 07/10→

Common Rail Diesel Injector

1.6 TDCi	70 kW	07/10→	T3DB	A2C59513556	18
			T3DA	A2C59513556	18
1.6 TDCi	85 kW	07/10→	T1DB	A2C59513556	18
			T1DA	A2C59513556	18
1.6 TDCi ECONetic	77 kW	05/12→	NGDA	A2C59513556	18

Diesel Common Rail Pump

1.6 TDCi	70 kW	07/10→	T3DA	A2C59513829	19
			T3DB	A2C59513829	19
1.6 TDCi	85 kW	07/10→	T1DA	A2C59513829	19
			T1DB	A2C59513829	19
1.6 TDCi ECONetic	77 kW	05/12→	NGDA	A2C59513829	19



VDO

**FORD - FOCUS III Saloon 07/10→****Common Rail Diesel Injector**

1.6 TDCi	70 kW	07/10→	T3DB	A2C59513556	18
			T3DA	A2C59513556	18
1.6 TDCi	85 kW	07/10→	T1DB	A2C59513556	18
			T1DA	A2C59513556	18

**Diesel Common Rail Pump**

1.6 TDCi	70 kW	07/10→	T3DA	A2C59513829	19
			T3DB	A2C59513829	19
1.6 TDCi	85 kW	07/10→	T1DA	A2C59513829	19
			T1DB	A2C59513829	19

FORD - FOCUS III Turnier 07/10→**Common Rail Diesel Injector**

1.6 TDCi	70 kW	07/10→	T3DB	A2C59513556	18
			T3DA	A2C59513556	18
1.6 TDCi	85 kW	07/10→	T1DB	A2C59513556	18
			T1DA	A2C59513556	18
1.6 TDCi EOnetic	77 kW	05/12→	NGDA	A2C59513556	18

**Diesel Common Rail Pump**

1.6 TDCi	70 kW	07/10→	T3DA	A2C59513829	19
			T3DB	A2C59513829	19
1.6 TDCi	85 kW	07/10→	T1DA	A2C59513829	19
			T1DB	A2C59513829	19
1.6 TDCi EOnetic	77 kW	05/12→	NGDA	A2C59513829	19

FORD - FOCUS IV (HN) 01/18→**Diesel Common Rail Pump**

2.0 EcoBlue	110 kW	01/18→		A2C1637670080	10
-------------	--------	--------	--	----------------------	----

FORD - FOCUS IV Turnier (HP) 09/18→**Diesel Common Rail Pump**

2.0 EcoBlue	110 kW	09/18→		A2C1637670080	10
-------------	--------	--------	--	----------------------	----

FORD - FOCUS C-MAX (DM2) 10/03→03/07**Common Rail Diesel Injector**

1.8 TDCi	85 kW	01/05→03/07	KKDA	A2C59511610	16
2.0 TDCi	100 kW	10/03→03/07	G6DA / G6DB / G6DD / G6DG; Version (C2): Class 4	5WS40156-4Z	9
			G6DA / G6DB / G6DD / G6DG; Version (C2): Class 5	5WS40156-Z	9
			G6DA / G6DB / G6DD / G6DG; Version (C2): Class 6	A2C59511601	14

**Diesel Common Rail Pump**

1.8 TDCi	85 kW	01/05→03/07	KKDA	A2C59511609	15
2.0 TDCi	100 kW	10/03→03/07	G6DD; 10/06	5WS40809-Z	10
			G6DG; 10/06	5WS40809-Z	10
			G6DA; 10/06	5WS40809-Z	10
			G6DB; 10/06	5WS40809-Z	10
			G6DB; 11/06 ; Specification (C3): Eurocode 223	A2C59511600	13
			G6DA; 11/06 ; Specification (C3): Eurocode 223	A2C59511600	13
			G6DG; 11/06 ; Specification (C3): Eurocode 223	A2C59511600	13
			G6DD; 11/06 ; Specification (C3): Eurocode 223	A2C59511600	13

FORD - FOCUS Saloon (DFW) 02/99→12/07**Common Rail Diesel Injector**

1.8 TDCi	74 kW	08/02→11/04	FFDA	A2C59511610	16
----------	-------	-------------	------	--------------------	----

**Diesel Common Rail Pump**

1.8 TDCi	74 kW	08/02→11/04	FFDA	A2C59511609	15
----------	-------	-------------	------	--------------------	----



VDO

FORD - FOCUS Turnier (DNW) 02/99→12/07

Common Rail Diesel Injector

1.8 TDCi	74 kW	08/02→11/04	FFDA	A2C59511610	16
----------	-------	-------------	------	-------------	----

Diesel Common Rail Pump

1.8 TDCi	74 kW	08/02→11/04	FFDA	A2C59511609	15
----------	-------	-------------	------	-------------	----

FORD - FUSION (JU_) 08/02→12/12

Common Rail Diesel Injector

1.4 TDCi	50 kW	08/02→12/12	F6JA	5WS40148-Z	8
			F6JB	A2C59511612	16

FORD - GALAXY (CK) 01/15→

Diesel Common Rail Pump

2.0 EcoBlue	88 kW	07/18→	YNCA	A2C1637670080	10
2.0 EcoBlue	110 kW	07/18→	YMCB	A2C1637670080	10
2.0 EcoBlue	140 kW	07/18→	BCCC	A2C1637670080	10
2.0 EcoBlue 4x4	110 kW	07/18→	YMCB	A2C1637670080	10
2.0 EcoBlue 4x4	140 kW	07/18→	BCCC	A2C1637670080	10

FORD - GALAXY (WM) 05/06→06/15

Common Rail Diesel Injector

1.6 TDCi	85 kW	02/11→06/15		A2C59513556	18
1.8 TDCi	74 kW	05/06→06/15	FFWA	A2C59511610	16
1.8 TDCi	92 kW	05/06→06/15	QYWA	A2C59511610	16
2.0 TDCi	100 kW	05/06→06/15	UKWA / AZWC	5WS40156-4Z	9
			AZWC / UKWA; Version (C2): Class 5	5WS40156-Z	9
			AZWC / UKWA; Version (C2): Class 6	A2C59511601	14
2.0 TDCi	103 kW	05/06→06/15	QXWA / QXWB / QXWC / UFWA; Version (C2): Class 4	5WS40156-4Z	9
			QXWA / QXWB / QXWC / UFWA; Version (C2): Class 5	5WS40156-Z	9
			QXWA / QXWB / QXWC / UFWA; Version (C2): Class 6	A2C59511601	14

Diesel Common Rail Pump

1.6 TDCi	85 kW	02/11→06/15		A2C59513829	19
1.8 TDCi	74 kW	05/06→06/15	FFWA	A2C59511609	15
1.8 TDCi	92 kW	05/06→06/15	QYWA	A2C59511609	15
2.0 TDCi	100 kW	05/06→06/15	UKWA	A2C59511600	13
			AZWC	A2C59511600	13
2.0 TDCi	103 kW	05/06→06/15	QXWB	A2C59511600	13
			QXWA	A2C59511600	13
			UFWA	A2C59511600	13
			QXWC	A2C59511600	13

FORD - GRAND C-MAX (DXA/CB7, DXA/CEU) 12/10→

Common Rail Diesel Injector

1.6 TDCi	70 kW	12/10→	T3DB	A2C59513556	18
			T3DA	A2C59513556	18
1.6 TDCi	85 kW	12/10→	T1DB	A2C59513556	18
			T1DA	A2C59513556	18

Diesel Common Rail Pump

1.6 TDCi	70 kW	12/10→	T3DA	A2C59513829	19
			T3DB	A2C59513829	19
1.6 TDCi	85 kW	12/10→	T1DA	A2C59513829	19
			T1DB	A2C59513829	19



VDO

**FORD - KUGA I 02/08→11/12****Common Rail Diesel Injector**

2.0 TDCi	100 kW	03/08→11/12	UKDA / G6DG; Version (C2): Class 4	5WS40156-4Z	9
			UKDA / G6DG; Version (C2): Class 5	5WS40156-Z	9
			UKDA / G6DG; Version (C2): Class 6	A2C59511601	14
2.0 TDCi	103 kW	03/10→11/12	UFDA; Version (C2): Class 4	5WS40156-4Z	9
			UFDA; Version (C2): Class 5	5WS40156-Z	9
			UFDA; Version (C2): Class 6	A2C59511601	14
2.0 TDCi 4x4	100 kW	03/08→11/12	G6DG / UKDA; Version (C2): Class 4	5WS40156-4Z	9
			G6DG / UKDA; Version (C2): Class 5	5WS40156-Z	9
			G6DG / UKDA; Version (C2): Class 6	A2C59511601	14
2.0 TDCi 4x4	103 kW	03/10→11/12	UFDA; Version (C2): Class 4	5WS40156-4Z	9
			UFDA; Version (C2): Class 5	5WS40156-Z	9
			UFDA; Version (C2): Class 6	A2C59511601	14

**Diesel Common Rail Pump**

2.0 TDCi	100 kW	03/08→11/12	UKDA	A2C59511600	13
			G6DG	A2C59511600	13
2.0 TDCi	103 kW	03/10→11/12	UFDA	A2C59511600	13
2.0 TDCi 4x4	100 kW	03/08→11/12	UKDA	A2C59511600	13
			G6DG	A2C59511600	13
2.0 TDCi 4x4	103 kW	03/10→11/12	UFDA	A2C59511600	13

FORD - MONDEO IV (BA7) 03/07→01/15**Common Rail Diesel Injector**

1.6 TDCi	85 kW	02/11→01/15	T1BB	A2C59513556	18
1.8 TDCi	74 kW	03/07→01/15	FFBA	A2C59511610	16
1.8 TDCi	92 kW	06/07→01/15	QYBA	A2C59511610	16
			KHBA	A2C59511610	16
2.0 TDCi	100 kW	03/07→12/14	UKBA / AZBC	5WS40156-4Z	9
			AZBC / UKBA; Version (C2): Class 5	5WS40156-Z	9
			AZBC / UKBA; Version (C2): Class 6	A2C59511601	14
2.0 TDCi	103 kW	03/07→01/15	QXBA / QXBB / UFBA; Version (C2): Class 4	5WS40156-4Z	9
			QXBA / QXBB / UFBA; Version (C2): Class 5	5WS40156-Z	9
			QXBA / QXBB / UFBA; Version (C2): Class 6	A2C59511601	14

**Diesel Common Rail Pump**

1.6 TDCi	85 kW	02/11→01/15	T1BB	A2C59513829	19
1.8 TDCi	74 kW	03/07→01/15	FFBA	A2C59511609	15
1.8 TDCi	92 kW	06/07→01/15	KHBA	A2C59511609	15
			QYBA	A2C59511609	15
2.0 TDCi	100 kW	03/07→12/14	UKBA	A2C59511600	13
			AZBC	A2C59511600	13
2.0 TDCi	103 kW	03/07→01/15	QXBA	A2C59511600	13
			QXBB	A2C59511600	13
			UFBA	A2C59511600	13

FORD - MONDEO IV Saloon (BA7) 03/07→01/15**Common Rail Diesel Injector**

1.8 TDCi	74 kW	03/07→01/15	FFBA	A2C59511610	16
1.8 TDCi	92 kW	06/07→01/15	KHBA	A2C59511610	16
			QYBA	A2C59511610	16
2.0 TDCi	103 kW	03/07→01/15	UFBA / QXBA / QXBB	5WS40156-4Z	9
			QXBA / QXBB / UFBA; Version (C2): Class 5	5WS40156-Z	9
			QXBA / QXBB / UFBA; Version (C2): Class 6	A2C59511601	14

**Diesel Common Rail Pump**

1.8 TDCi	74 kW	03/07→01/15	FFBA	A2C59511609	15
1.8 TDCi	92 kW	06/07→01/15	KHBA	A2C59511609	15
			QYBA	A2C59511609	15



VDO

FORD - MONDEO IV Saloon (BA7) 03/07→01/15

Diesel Common Rail Pump

2.0 TDCi	103 kW	03/07→01/15	QXBA	A2C59511600	13
			QXBB	A2C59511600	13
			UFBA	A2C59511600	13

FORD - MONDEO IV Turnier (BA7) 03/07→01/15

Common Rail Diesel Injector

1.6 TDCi	85 kW	02/11→01/15	T1BB	A2C59513556	18
1.8 TDCi	74 kW	03/07→12/12	FFBA	A2C59511610	16
1.8 TDCi	92 kW	06/07→12/12	QYBA	A2C59511610	16
			KHBA	A2C59511610	16
2.0 TDCi	100 kW	03/07→12/14	UKBA / AZBC; Version (C2): Class 4	5WS40156-4Z	9
			UKBA / AZBC; Version (C2): Class 5	5WS40156-Z	9
			UKBA / AZBC; Version (C2): Class 6	A2C59511601	14
2.0 TDCi	103 kW	03/07→01/15	QXBA / QXBB / UFBA; Version (C2): Class 4	5WS40156-4Z	9
			QXBA / QXBB / UFBA; Version (C2): Class 5	5WS40156-Z	9
			QXBA / QXBB / UFBA; Version (C2): Class 6	A2C59511601	14

Diesel Common Rail Pump

1.6 TDCi	85 kW	02/11→01/15	T1BB	A2C59513829	19
1.8 TDCi	74 kW	03/07→12/12	FFBA	A2C59511609	15
1.8 TDCi	92 kW	06/07→12/12	KHBA	A2C59511609	15
			QYBA	A2C59511609	15
2.0 TDCi	100 kW	03/07→12/14	UKBA	A2C59511600	13
			AZBC	A2C59511600	13
2.0 TDCi	103 kW	03/07→01/15	QXBA	A2C59511600	13
			QXBB	A2C59511600	13
			UFBA	A2C59511600	13

FORD - RANGER (TKE) 04/11→

Common Rail Diesel Injector

2.2 TDCi	88 kW	04/11→	GBVAJPF; Production date to (C29): 14.09.2015	A2C59517051	21
			GBVAJPF; Production date from (C28): 15.09.2015	A2C8139490080	21
2.2 TDCi	92 kW	04/11→	GBVAJQW; Production date to (C29): 14.09.2015	A2C59517051	21
2.2 TDCi	96 kW	05/15→	Production date to (C29): 14.09.2015	A2C59517051	21
			Production date from (C28): 15.09.2015	A2C8139490080	21
2.2 TDCi	110 kW	11/11→	GBVAJQJ; Production date to (C29): 14.09.2015	A2C59517051	21
			GBVAJQJ; Production date from (C28): 15.09.2015	A2C8139490080	21
2.2 TDCi 4x4	92 kW	04/11→	GBVAJQW; Production date to (C29): 14.09.2015	A2C59517051	21
2.2 TDCi 4x4	96 kW	05/15→	Production date to (C29): 14.09.2015	A2C59517051	21
			Production date from (C28): 15.09.2015	A2C8139490080	21
2.2 TDCi 4x4	110 kW	04/11→	GBVAJQJ; Production date to (C29): 14.09.2015	A2C59517051	21
			GBVAJQJ; Production date from (C28): 15.09.2015	A2C8139490080	21
3.2 TDCi 4x4	147 kW	04/11→	SAFA; Production date to (C29): 14.09.2015	A2C59517051	21
			SAFA; Production date from (C28): 15.09.2015	A2C8139490080	21

Diesel Common Rail Pump

2.2 TDCi	88 kW	04/11→	GBVAJPF; 09/11	A2C59517043	20
			GBVAJPF; 09/11 - 10/11	A2C59517043	20
2.2 TDCi	92 kW	04/11→	GBVAJQW; 09/11	A2C59517043	20
			GBVAJQW; 09/11 - 10/11	A2C59517043	20
2.2 TDCi	96 kW	05/15→	Production date from (C28): 14.09.2015	A2C9321760080	21
2.2 TDCi	110 kW	11/11→	GBVAJQJ	A2C59517043	20
2.2 TDCi	118 kW	05/15→	Production date from (C28): 14.09.2015	A2C9321760080	21
2.2 TDCi 4x4	92 kW	04/11→	GBVAJQW; 09/11	A2C59517043	20
			GBVAJQW; 09/11 - 10/11	A2C59517043	20
2.2 TDCi 4x4	96 kW	05/15→	Production date from (C28): 14.09.2015	A2C9321760080	21
2.2 TDCi 4x4	110 kW	04/11→	GBVAJQJ; 09/11 - 10/11	A2C59517043	20
			GBVAJQJ; 09/11	A2C59517043	20
2.2 TDCi 4x4	118 kW	05/15→	Production date from (C28): 14.09.2015	A2C9321760080	21



VDO

**FORD - RANGER (TKE) 04/11→**

Diesel Common Rail Pump					
3.2 TDCi 4x4	147 kW	04/11→	SAFA; 09/11 10/11	A2C59517043	20
			SAFA; 09/11	A2C59517043	20

Distributor Pipe, fuel

2.2 TDCi	88 kW	04/11→	GBVAJPF	A2C5328876880	10
2.2 TDCi	96 kW	05/15→		A2C5328876880	10
2.2 TDCi	110 kW	11/11→	GBVAJQJ	A2C5328876880	10
2.2 TDCi 4x4	96 kW	05/15→		A2C5328876880	10
2.2 TDCi 4x4	110 kW	04/11→	GBVAJQJ	A2C5328876880	10

FORD - S-MAX (CJ) 01/15→

Diesel Common Rail Pump					
2.0 EcoBlue	88 kW	07/18→	YNCA	A2C1637670080	10
2.0 EcoBlue	110 kW	07/18→	YMCB	A2C1637670080	10
2.0 EcoBlue	140 kW	07/18→	BCCC	A2C1637670080	10
2.0 EcoBlue 4x4	110 kW	07/18→	YMCB	A2C1637670080	10
2.0 EcoBlue 4x4	140 kW	07/18→	BCCC	A2C1637670080	10

FORD - S-MAX (WS) 05/06→12/14

Common Rail Diesel Injector					
1.6 TDCi	85 kW	02/11→12/14		A2C59513556	18
1.8 TDCi	74 kW	01/07→12/10	FFWA	A2C59511610	16
1.8 TDCi	92 kW	05/06→12/14	QYWA	A2C59511610	16
2.0 TDCi	100 kW	05/06→12/14	UKWA / AZWC; Version (C2): Class 4	5WS40156-4Z	9
			UKWA / AZWC; Version (C2): Class 5	5WS40156-Z	9
			AZWC / UKWA	A2C59511601	14
2.0 TDCi	103 kW	05/06→12/14	QXWA / QXWB / QXWC / UFWA; Version (C2): Class 4	5WS40156-4Z	9
			QXWA / QXWB / QXWC / UFWA; Version (C2): Class 5	5WS40156-Z	9
			QXWC / QXWA / QXWB / UFWA	A2C59511601	14

Diesel Common Rail Pump					
1.6 TDCi	85 kW	02/11→12/14		A2C59513829	19
1.8 TDCi	74 kW	01/07→12/10	FFWA	A2C59511609	15
1.8 TDCi	92 kW	05/06→12/14	QYWA	A2C59511609	15
2.0 TDCi	100 kW	05/06→12/14	UKWA	A2C59511600	13
			AZWC	A2C59511600	13
2.0 TDCi	103 kW	05/06→12/14	QXWB	A2C59511600	13
			QXWA	A2C59511600	13
			UFWA	A2C59511600	13
			QXWC	A2C59511600	13

FORD - TOURNEO CONNECT 06/02→12/13

Common Rail Diesel Injector					
1.8 TDCi	66 kW	06/02→12/13	08/06 ; RWPF / HCPA / HCPB / R3PA / P9PD / P9PA / P9PC / P9PB / RWPE	A2C59511610	16
			08/06 ; RWPF, HCPA, HCPB / R3PA, P9PD, P9PA / P9PC, P9PB, RWPE	A2C59511611	16
1.8 TDCi	81 kW	08/06→12/13	RWPD	A2C59511610	16
			RWPC	A2C59511610	16
			RWPA	A2C59511610	16
1.8 TDCi / TDDi / DI	55 kW	06/02→12/13	08/06 ; P7PA / P7PB / R2PA / BHPA	A2C59511610	16
			08/06 ; P7PA, P7PB / R2PA, BHPA	A2C59511611	16

Diesel Common Rail Pump					
1.8 TDCi	66 kW	06/02→12/13	08/06 ; RWPF / HCPA / HCPB / R3PA / P9PD / P9PA / P9PC / P9PB / RWPE	A2C59511609	15



VDO

FORD - TOURNEO CONNECT 06/02→12/13

Diesel Common Rail Pump

1.8 TDCi	81 kW	08/06→12/13	RWPA	A2C59511609	15
			RWPC	A2C59511609	15
			RWPD	A2C59511609	15
1.8 TDCi /TDDi /DI	55 kW	06/02→12/13	08/06 ; P7PA / P7PB / R2PA / BHPA	A2C59511609	15

FORD - TOURNEO CUSTOM Bus 04/12→

Common Rail Diesel Injector

2.2 TDCi	74 kW	04/12→		A2C59517051	21
2.2 TDCi	92 kW	04/12→			
2.2 TDCi	114 kW	04/12→			

Diesel Common Rail Pump

2.0 TDCi	77 kW	12/15→		A2C1637670080	10
2.0 TDCi	96 kW	12/15→			
2.2 TDCi	74 kW	04/12→		A2C59517045	20
2.2 TDCi	92 kW	04/12→			
2.2 TDCi	114 kW	04/12→			

Distributor Pipe, fuel

2.2 TDCi	74 kW	04/12→	DRF4 / DRFF / DRFG; 12/14	A2C5328876880	10
2.2 TDCi	92 kW	04/12→	CYF4 / CYFF; 12/14	A2C5328876880	10
2.2 TDCi	114 kW	04/12→	CVFF; 12/14	A2C5328876880	10

FORD - TRANSIT Box 08/13→

Common Rail Diesel Injector

2.2 TDCi	74 kW	08/13→	DRFG / DRF5 / DRFF	A2C59517051	21
2.2 TDCi	92 kW	08/13→	USF6 / CYFG / CYF5 / CY14	A2C59517051	21
2.2 TDCi	114 kW	08/13→	CVF5	A2C59517051	21
2.2 TDCi 4x4	92 kW	08/13→	CYR5 / CY24	A2C59517051	21
2.2 TDCi 4x4	114 kW	08/13→	CVR5 / CV24	A2C59517051	21
2.2 TDCi RWD	74 kW	08/13→	DRR5	A2C59517051	21
2.2 TDCi RWD	92 kW	08/13→	USR6	A2C59517051	21
2.2 TDCi RWD	114 kW	08/13→	CV24 / CVR5 / UYR6	A2C59517051	21

Diesel Common Rail Pump

2.0 TDCi	77 kW	03/16→		A2C1637670080	10
2.0 TDCi	96 kW	03/16→			
2.0 TDCi 4x4	96 kW	01/17→			
2.0 TDCi RWD	77 kW	03/16→			
2.0 TDCi RWD	96 kW	03/16→			
2.2 TDCi	74 kW	08/13→	DRF5 / DRFF / DRFG	A2C59517045	20
2.2 TDCi	92 kW	08/13→	CY14 / CYF5 / CYFG	A2C59517045	20
2.2 TDCi	114 kW	08/13→	CVF5	A2C59517045	20
2.2 TDCi 4x4	92 kW	08/13→	CY24 / CYR5	A2C59517045	20
2.2 TDCi 4x4	114 kW	08/13→	CV24 / CVR5	A2C59517045	20
2.2 TDCi RWD	74 kW	08/13→	DRR5	A2C59517045	20
2.2 TDCi RWD	92 kW	08/13→	CYR5 / USR6	A2C59517045	20
2.2 TDCi RWD	114 kW	08/13→	CV24 / CVR5 / UYR6	A2C59517045	20

Distributor Pipe, fuel

2.2 TDCi	74 kW	08/13→	DRF5 / DRFF / DRFG; 12/14	A2C5328876880	10
2.2 TDCi	92 kW	08/13→	USF6 / CYFG / CYF5 / CY14; 12/14	A2C5328876880	10
2.2 TDCi	114 kW	08/13→	CVF5; 12/14	A2C5328876880	10
2.2 TDCi 4x4	92 kW	08/13→	CY24 / CYR5; 12/14	A2C5328876880	10
2.2 TDCi 4x4	114 kW	08/13→	CV24 / CVR5; 12/14	A2C5328876880	10
2.2 TDCi RWD	74 kW	08/13→	DRR5; 12/14	A2C5328876880	10
2.2 TDCi RWD	92 kW	08/13→	USR6; 12/14	A2C5328876880	10
2.2 TDCi RWD	114 kW	08/13→	CV24 / CVR5 / UYR6; 12/14	A2C5328876880	10



VDO

**FORD - TRANSIT Box (FA_ _) 04/06→****Common Rail Diesel Injector**

2.2 TDCi	74 kW	10/11→08/14	DRFA	A2C59517051	21
			DRFE	A2C59517051	21
			DRFB	A2C59517051	21
			DRFD	A2C59517051	21
			DRFC	A2C59517051	21
2.2 TDCi	92 kW	10/11→08/14	CYFB	A2C59517051	21
			CYFA	A2C59517051	21
			CYFD	A2C59517051	21
			CYFC	A2C59517051	21
2.2 TDCi	103 kW	10/07→08/14	PGFB	A2C59517051	21
			UHFA	A2C59517051	21
2.2 TDCi 4x4	92 kW	10/11→08/14	CYRB	A2C59517051	21
			CYRC	A2C59517051	21
2.2 TDCi RWD	74 kW	10/11→08/14		A2C59517051	21
2.2 TDCi RWD	92 kW	10/11→08/14			
2.2 TDCi RWD	114 kW	10/11→08/14			

**Diesel Common Rail Pump**

2.2 TDCi	74 kW	10/11→08/14	DRFE; 10/11	A2C59517043	20
			DRFD; 10/11	A2C59517043	20
			DRFB; 10/11	A2C59517043	20
			DRFA; 10/11	A2C59517043	20
			DRFC; 10/11	A2C59517043	20
2.2 TDCi	92 kW	10/11→08/14	CYFB; 10/11	A2C59517043	20
			CYFA; 10/11	A2C59517043	20
			CYFD; 10/11	A2C59517043	20
			CYFC; 10/11	A2C59517043	20
			CYFA	A2C59517045	20
2.2 TDCi	103 kW	10/07→08/14	UHFA; 10/11	A2C59517043	20
			UHFC; 09/11	A2C59517043	20
			PGFB; 09/11	A2C59517043	20
			PGFA; 10/11	A2C59517043	20
			UHFB; 10/11	A2C59517043	20
			UHFC; 10/11	A2C59517043	20
			PGFB; 10/11	A2C59517043	20
			UHFB; 09/11	A2C59517043	20
			UHFB; 09/11 10/11	A2C59517043	20
			PGFA; 09/11 10/11	A2C59517043	20
			PGFB; 09/11 10/11	A2C59517043	20
			UHFA; 09/11 10/11	A2C59517043	20
			UHFA; 09/11	A2C59517043	20
			PGFA; 09/11	A2C59517043	20
			UHFC; 09/11 10/11	A2C59517043	20
2.2 TDCi 4x4	92 kW	10/11→08/14	CYRC; 10/11	A2C59517043	20
			CYRB; 10/11	A2C59517043	20
			CYRC	A2C59517045	20
2.2 TDCi RWD	74 kW	10/11→08/14		A2C59517043	20
2.2 TDCi RWD	92 kW	10/11→08/14		A2C59517045	20
2.2 TDCi RWD	114 kW	10/11→08/14			

Distributor Pipe, fuel

2.2 TDCi	74 kW	10/11→08/14	DRFA / DRFB / DRFC / DRFD / DRFE	A2C5328876880	10
2.2 TDCi	92 kW	10/11→08/14	CYFA / CYFB / CYFC / CYFD	A2C5328876880	10
2.2 TDCi	103 kW	10/07→08/14	PGFA / PGFB / UHFA / UHFB / UHFC; 10/11	A2C5328876880	10
2.2 TDCi 4x4	92 kW	10/11→08/14	CYRB / CYRC	A2C5328876880	10
2.2 TDCi RWD	74 kW	10/11→08/14	DRRR / DRRB / DRRC	A2C5328876880	10
2.2 TDCi RWD	92 kW	10/11→08/14	CYRA / CYRB	A2C5328876880	10
2.2 TDCi RWD	100 kW	10/11→08/14	USRA / USRB	A2C5328876880	10
2.2 TDCi RWD	114 kW	10/11→08/14	CVRA / CVRB / CVRC; 12/14	A2C5328876880	10



VDO

FORD - TRANSIT Bus 08/13→

Common Rail Diesel Injector

2.2 TDCi	74 kW	08/13→	DRFF / DRF5 / DRFG	A2C59517051	21
2.2 TDCi	92 kW	08/13→	CY14 / CYF5 / CYFG	A2C59517051	21
2.2 TDCi	114 kW	12/14→	CVF5	A2C59517051	21
2.2 TDCi 4x4	92 kW	08/13→	CY24 / CYR5	A2C59517051	21
2.2 TDCi RWD	74 kW	08/13→	DRR5	A2C59517051	21
2.2 TDCi RWD	92 kW	08/13→	USR6	A2C59517051	21
2.2 TDCi RWD	99 kW	08/13→	UHR5	A2C59517051	21
2.2 TDCi RWD	114 kW	08/13→	CV24 / CVR5 / UYR6	A2C59517051	21

Diesel Common Rail Pump

2.0 TDCi	77 kW	03/16→		A2C1637670080	10
2.0 TDCi	96 kW	03/16→			
2.2 TDCi	74 kW	08/13→	DRF5 / DRFF / DRFG	A2C59517045	20
2.2 TDCi	92 kW	08/13→	CY14 / CYF5 / CYFG	A2C59517045	20
2.2 TDCi	114 kW	12/14→	CVF5	A2C59517045	20
2.2 TDCi 4x4	92 kW	08/13→	CY24 / CYR5	A2C59517045	20
2.2 TDCi All-wheel Drive	114 kW	12/14→		A2C59517045	20
2.2 TDCi RWD	74 kW	08/13→	DRR5	A2C59517045	20
2.2 TDCi RWD	92 kW	08/13→	USR6	A2C59517045	20
2.2 TDCi RWD	99 kW	08/13→	UHR5	A2C59517045	20
2.2 TDCi RWD	114 kW	08/13→	CV24 / CVR5 / UYR6	A2C59517045	20

Distributor Pipe, fuel

2.2 TDCi	74 kW	08/13→	DRF5 / DRFF / DRFG; - 12/14	A2C5328876880	10
2.2 TDCi	92 kW	08/13→	CY14 / CYF5 / CYFG; - 12/14	A2C5328876880	10
2.2 TDCi 4x4	92 kW	08/13→	CY24 / CYR5; - 12/14	A2C5328876880	10
2.2 TDCi RWD	74 kW	08/13→	DRR5; - 12/14	A2C5328876880	10
2.2 TDCi RWD	92 kW	08/13→	USR6; - 12/14	A2C5328876880	10
2.2 TDCi RWD	99 kW	08/13→	UHR5; - 12/14	A2C5328876880	10
2.2 TDCi RWD	114 kW	08/13→	CV24 / CVR5 / UYR6; - 12/14	A2C5328876880	10

FORD - TRANSIT Bus (FD __, FB __, FS __, FZ __, FC __) 04/06→

Common Rail Diesel Injector

2.2 TDCi	74 kW	10/11→08/14	DRFB	A2C59517051	21
			DRFC	A2C59517051	21
2.2 TDCi	92 kW	10/11→08/14	CYFB	A2C59517051	21
			CYFA	A2C59517051	21
			CYFD	A2C59517051	21
			CYFC	A2C59517051	21
2.2 TDCi	103 kW	10/07→08/14	PGFA	A2C59517051	21
2.2 TDCi RWD	74 kW	10/11→08/14		A2C59517051	21
2.2 TDCi RWD	92 kW	10/11→08/14			
2.2 TDCi RWD	100 kW	09/11→08/14			

Diesel Common Rail Pump

2.2 TDCi	74 kW	10/11→08/14	DRFB; - 10/11	A2C59517043	20
			DRFE; - 10/11	A2C59517043	20
			DRFD; - 10/11	A2C59517043	20
			DRFA; - 10/11	A2C59517043	20
			DRFC; - 10/11	A2C59517043	20
			DRFB	A2C59517045	20
2.2 TDCi	92 kW	10/11→08/14	CYFB; - 10/11	A2C59517043	20
			CYFA; - 10/11	A2C59517043	20
			CYFD; - 10/11	A2C59517043	20
			CYFC; - 10/11	A2C59517043	20
2.2 TDCi	103 kW	10/07→08/14	CYFA	A2C59517045	20
			UHFA; - 09/11 - 10/11	A2C59517043	20
			UHFB; - 09/11 - 10/11	A2C59517043	20
			UHFA; - 10/11	A2C59517043	20
			PGFA; - 10/11	A2C59517043	20
UHFB; - 10/11	A2C59517043	20			

→



VDO

**FORD - TRANSIT Bus (FD_, FB_, FS_, FZ_, FC_) 04/06→****Diesel Common Rail Pump**

2.2 TDCi	103 kW	10/07→08/14	UHFC; 10/11	A2C59517043	20
			PGFB; 10/11	A2C59517043	20
			PGFB; 09/11	A2C59517043	20
			PGFA; 09/11	A2C59517043	20
			PGFB; 09/11 - 10/11	A2C59517043	20
			UHFC; 09/11 - 10/11	A2C59517043	20
			UHFA; 09/11	A2C59517043	20
			UHFC; 09/11	A2C59517043	20
			UHFB; 09/11	A2C59517043	20
			PGFA; 09/11 - 10/11	A2C59517043	20
2.2 TDCi RWD	74 kW	10/11→08/14		A2C59517045	20
2.2 TDCi RWD	92 kW	10/11→08/14		A2C59517045	20
2.2 TDCi RWD	100 kW	09/11→08/14	10/11	A2C59517043	20
				A2C59517045	20

Distributor Pipe, fuel

2.2 TDCi	74 kW	10/11→08/14	DRFA / DRFB / DRFC / DRFD / DRFE	A2C5328876880	10
2.2 TDCi	92 kW	10/11→08/14	CYFA / CYFB / CYFC / CYFD	A2C5328876880	10
2.2 TDCi	103 kW	10/07→08/14	PGFA / PGFB / UHFA / UHFB / UHFC; 10/11	A2C5328876880	10
2.2 TDCi RWD	74 kW	10/11→08/14	DRRR / DRRB / DRRC	A2C5328876880	10
2.2 TDCi RWD	92 kW	10/11→08/14	CYRA / CYRB	A2C5328876880	10
2.2 TDCi RWD	100 kW	09/11→08/14	USRA / USRB	A2C5328876880	10

FORD - TRANSIT CONNECT (P65_, P70_, P80_) 06/02→**Common Rail Diesel Injector**

1.8 Di	55 kW	06/02→12/13	12/07	A2C59511610	16
			12/07 ; P7PA, P7PB / BHPA, R2PA	A2C59511611	16
1.8 TDCi	66 kW	06/02→12/13	08/06 ; P9PD / R3PA / P9PB / P9PC / RWPE / HCPA / HCPB / P9PA / RWPF	A2C59511610	16
			08/06 ; P9PD, R3PA, P9PB / P9PC, RWPE, HCPA / HCPB, P9PA, RWPF	A2C59511611	16
1.8 TDCi	81 kW	08/06→12/13	RWPD	A2C59511610	16
			RWPC	A2C59511610	16
			RWPA	A2C59511610	16

**Diesel Common Rail Pump**

1.8 Di	55 kW	06/02→12/13	12/07 ; P7PA / BHPA / P7PB / R2PA	A2C59511609	15
1.8 TDCi	66 kW	06/02→12/13	08/06 ; P9PD / R3PA / P9PB / P9PC / RWPE / HCPA / HCPB / P9PA / RWPF	A2C59511609	15
1.8 TDCi	81 kW	08/06→12/13	RWPA	A2C59511609	15
			RWPC	A2C59511609	15
			RWPD	A2C59511609	15

FORD - TRANSIT CUSTOM Box 04/12→**Common Rail Diesel Injector**

2.2 TDCi	74 kW	04/12→		A2C59517051	21
2.2 TDCi	92 kW	04/12→			
2.2 TDCi	114 kW	04/12→			

**Diesel Common Rail Pump**

2.0 TDCi	77 kW	12/15→		A2C1637670080	10
2.0 TDCi	96 kW	12/15→			
2.2 TDCi	74 kW	04/12→		A2C59517045	20
2.2 TDCi	92 kW	04/12→			
2.2 TDCi	114 kW	04/12→			

Distributor Pipe, fuel

2.2 TDCi	74 kW	04/12→	DRF4 / DRFF / DRFG; 12/14	A2C5328876880	10
2.2 TDCi	92 kW	04/12→	CYF4 / CYFF; 12/14	A2C5328876880	10
2.2 TDCi	114 kW	04/12→	CVFF; 12/14	A2C5328876880	10



VDO

FORD - TRANSIT CUSTOM Bus 04/12→

Common Rail Diesel Injector

2.2 TDCi	74 kW	04/12→		A2C59517051	21
2.2 TDCi	92 kW	04/12→			
2.2 TDCi	114 kW	04/12→			

Diesel Common Rail Pump

2.0 TDCi	77 kW	12/15→		A2C1637670080	10
2.0 TDCi	96 kW	12/15→			
2.2 TDCi	74 kW	04/12→		A2C59517045	20
2.2 TDCi	92 kW	04/12→			
2.2 TDCi	114 kW	04/12→			

Distributor Pipe, fuel

2.2 TDCi	74 kW	04/12→	DRF4 / DRFF / DRFG; - 12/14	A2C5328876880	10
2.2 TDCi	92 kW	04/12→	CYF4 / CYFF; - 12/14	A2C5328876880	10
2.2 TDCi	114 kW	04/12→	CVFF; - 12/14	A2C5328876880	10

FORD - TRANSIT Platform/Chassis 08/13→

Common Rail Diesel Injector

2.2 TDCi	74 kW	08/13→	DRF5 / DRFG / DRFF	A2C59517051	21
2.2 TDCi	92 kW	08/13→	CYF5	A2C59517051	21
2.2 TDCi	114 kW	08/13→	CVF5	A2C59517051	21
2.2 TDCi 4x4	92 kW	08/13→	CYR5 / CY24	A2C59517051	21
2.2 TDCi 4x4	114 kW	08/13→	CV24 / CVR5	A2C59517051	21
2.2 TDCi RWD	74 kW	08/13→	DRR5	A2C59517051	21
2.2 TDCi RWD	92 kW	08/13→	USR6	A2C59517051	21
2.2 TDCi RWD	99 kW	08/13→	UHR5	A2C59517051	21
2.2 TDCi RWD	114 kW	08/13→	CVR5 / UYR6 / CV24	A2C59517051	21

Diesel Common Rail Pump

2.0 TDCi	77 kW	03/16→		A2C1637670080	10
2.0 TDCi	96 kW	03/16→			
2.0 TDCi 4x4	96 kW	01/17→			
2.0 TDCi RWD	77 kW	03/16→			
2.0 TDCi RWD	96 kW	03/16→			
2.2 TDCi	74 kW	08/13→	DRF5 / DRFF / DRFG	A2C59517045	20
2.2 TDCi	92 kW	08/13→	CYF5	A2C59517045	20
2.2 TDCi	114 kW	08/13→	CVF5	A2C59517045	20
2.2 TDCi 4x4	92 kW	08/13→	CY24 / CYR5	A2C59517045	20
2.2 TDCi 4x4	114 kW	08/13→	CV24 / CVR5	A2C59517045	20
2.2 TDCi RWD	74 kW	08/13→	DRR5	A2C59517045	20
2.2 TDCi RWD	92 kW	08/13→	USR6	A2C59517045	20
2.2 TDCi RWD	99 kW	08/13→	UHR5	A2C59517045	20
2.2 TDCi RWD	114 kW	08/13→	CV24 / CVR5 / UYR6	A2C59517045	20

Distributor Pipe, fuel

2.2 TDCi	74 kW	08/13→	DRF5 / DRFF / DRFG; - 12/14	A2C5328876880	10
2.2 TDCi	92 kW	08/13→	CYF5; - 12/14	A2C5328876880	10
2.2 TDCi	114 kW	08/13→	CVF5; - 12/14	A2C5328876880	10
2.2 TDCi 4x4	92 kW	08/13→	CY24 / CY25; - 12/14	A2C5328876880	10
2.2 TDCi 4x4	114 kW	08/13→	CV24 / CVR5; - 12/14	A2C5328876880	10
2.2 TDCi RWD	74 kW	08/13→	DRR5; - 12/14	A2C5328876880	10
2.2 TDCi RWD	92 kW	08/13→	USR6; - 12/14	A2C5328876880	10
2.2 TDCi RWD	99 kW	08/13→	UHR5; - 12/14	A2C5328876880	10
2.2 TDCi RWD	114 kW	08/13→	CV24 / CVR5 / UYR6; - 12/14	A2C5328876880	10

FORD - TRANSIT Platform/Chassis (FM_ , FN_) 04/06→08/14

Common Rail Diesel Injector

2.2 TDCi	74 kW	10/11→08/14	DRFA	A2C59517051	21
			DRFE	A2C59517051	21
			DRFB	A2C59517051	21
			DRFD	A2C59517051	21
			DRFC	A2C59517051	21



VDO

**FORD - TRANSIT Platform/Chassis (FM_ , FN_) 04/06→08/14****Common Rail Diesel Injector**

2.2 TDCi	92 kW	10/11→08/14	CYFB	A2C59517051	21
			CYFA	A2C59517051	21
			CYFD	A2C59517051	21
			CYFC	A2C59517051	21
2.2 TDCi	103 kW	10/07→09/11	PGFB	A2C59517051	21
			UHFC	A2C59517051	21
2.2 TDCi 4x4	92 kW	10/11→08/14	CYRB	A2C59517051	21
2.2 TDCi RWD	74 kW	10/11→08/14		A2C59517051	21
2.2 TDCi RWD	92 kW	10/11→08/14			
2.2 TDCi RWD	114 kW	10/11→08/14			

**Diesel Common Rail Pump**

2.2 TDCi	74 kW	10/11→08/14	DRFB; 10/11	A2C59517043	20
			DRFE; 10/11	A2C59517043	20
			DRFD; 10/11	A2C59517043	20
			DRFA; 10/11	A2C59517043	20
			DRFC; 10/11	A2C59517043	20
			DRFE	A2C59517045	20
2.2 TDCi	92 kW	10/11→08/14	CYFB; 10/11	A2C59517043	20
			CYFA; 10/11	A2C59517043	20
			CYFD; 10/11	A2C59517043	20
			CYFC; 10/11	A2C59517043	20
			CYFA	A2C59517045	20
			CYFB	A2C59517045	20
2.2 TDCi	103 kW	10/07→09/11	CYFD	A2C59517045	20
			UHFC; 09/11	A2C59517043	20
			PGFB; 09/11	A2C59517043	20
			UHFB; 09/11	A2C59517043	20
			PGFA; 09/11	A2C59517043	20
			UHFA; 09/11	A2C59517043	20
2.2 TDCi 4x4	92 kW	10/11→08/14	CYRC; 10/11	A2C59517043	20
			CYRB; 10/11	A2C59517043	20
			CYRB	A2C59517045	20
			CYRC	A2C59517045	20
2.2 TDCi RWD	74 kW	10/11→08/14		A2C59517045	20
2.2 TDCi RWD	92 kW	10/11→08/14			
2.2 TDCi RWD	114 kW	10/11→08/14			

Distributor Pipe, fuel

2.2 TDCi	74 kW	10/11→08/14	DRFA / DRFB / DRFC / DRFD / DRFE	A2C5328876880	10
2.2 TDCi	92 kW	10/11→08/14	CYFA / CYFB / CYFC / CYFD	A2C5328876880	10
2.2 TDCi 4x4	92 kW	10/11→08/14	CYRB / CYRC	A2C5328876880	10
2.2 TDCi RWD	74 kW	10/11→08/14	DRRR / DRRB / DRRC	A2C5328876880	10
2.2 TDCi RWD	92 kW	10/11→08/14	CYRA / CYRB	A2C5328876880	10
2.2 TDCi RWD	114 kW	10/11→08/14	CVRA / CVRB / CVRC	A2C5328876880	10

FORD - TRANSIT TOURNEO 07/06→08/14**Common Rail Diesel Injector**

2.2 TDCi	103 kW	10/07→08/14	PGFA	A2C59517051	21
----------	--------	-------------	------	-------------	----

**Diesel Common Rail Pump**

2.2	92 kW	10/11→08/14	CYFA / CYFB	A2C59517045	20
2.2 TDCi	81 kW	07/06→08/14	QVFA	A2C59517045	20
2.2 TDCi	85 kW	10/08→08/14	SRFA / SRFB / SRFC / SRFE	A2C59517045	20
2.2 TDCi	96 kW	07/06→08/14	QWFA	A2C59517045	20
2.2 TDCi	103 kW	10/07→08/14	PGFB; 09/11	A2C59517043	20
			PGFA; 10/11	A2C59517043	20
			PGFB; 10/11	A2C59517043	20
			PGFA; 09/11	A2C59517043	20
			PGFA; 09/11 10/11	A2C59517043	20
			PGFA / PGFB / UHFA / UHFC	A2C59517045	20
			PGFA / PGFB / UHFA / UHFC	A2C59517045	20



JAGUAR - S-TYPE (X200) 10/98→12/08					
Common Rail Diesel Injector					
2.7 D	152 kW	06/04→10/07	AJD	A2C59511316	12
Distributor Pipe, fuel					
2.7 D	152 kW	06/04→10/07	AJD; ↕ Fuel Rail (V240)	A2C59511317	12
			AJD; ↕	A2C59511318	12
			AJD; ↕	A2C59511319	13
JAGUAR - XF (X250) 03/08→04/15					
Common Rail Diesel Injector					
2.7 D	152 kW	03/08→04/15	AJD	A2C59511316	12
Distributor Pipe, fuel					
2.7 D	152 kW	03/08→04/15	AJD; ↕ Fuel Rail (V240)	A2C59511317	12
			AJD; ↕	A2C59511318	12
			AJD; ↕	A2C59511319	13
LAND ROVER - DEFENDER Cabrio (L316) 08/90→02/16					
Common Rail Diesel Injector					
2.2 Td4 4x4 (L317)	90 kW	08/11→02/16	ZSD-422; → CA000001	2910000177400	8
LAND ROVER - DEFENDER Pickup (L316) 10/95→02/16					
Common Rail Diesel Injector					
2.2 Td4 4x4 (L317)	90 kW	08/11→02/16	ZSD-422; → CA000001	2910000177400	8
LAND ROVER - DEFENDER Platform/Chassis (L316) 09/90→02/16					
Common Rail Diesel Injector					
2.2 Td4 4x4 (L317)	90 kW	08/11→02/16	ZSD-422; → CA000001	2910000177400	8
LAND ROVER - DEFENDER Station Wagon (L316) 08/90→02/16					
Common Rail Diesel Injector					
2.2 Td4 4x4 (L317)	90 kW	08/11→02/16	ZSD-422; → CA000001	2910000177400	8
LAND ROVER - DISCOVERY III (L319) 07/04→09/09					
Common Rail Diesel Injector					
2.7 TD 4x4	140 kW	07/04→09/09	276DT	A2C59511364	13
			276DT; → 7A000001	A2C59513553	17
Diesel Common Rail Pump					
2.7 TD 4x4	140 kW	07/04→09/09	276DT; → 9A509803	A2C59513482	17
			276DT; → 7A000001 → 9A509802	A2C59513482	17
			276DT; → 7A000001 → 8A463765	A2C59513482	17
			276DT; → 8A463766 → 9A509802	A2C59513482	17
Distributor Pipe, fuel					
2.7 TD 4x4	140 kW	07/04→09/09	276DT; ↕ Fuel Rail (V240)	A2C59511317	12
			276DT; → 8A999999; ↕ Fuel Rail (V240)	A2C59511317	12
			276DT; → 9A000001 ; ↕ Fuel Rail (V240)	A2C59511317	12
			276DT; → 9A000001 ; ↕	A2C59511318	12
			276DT; ↕	A2C59511318	12
			276DT; → 8A999999; ↕	A2C59511318	12
			276DT; → 8A999999; ↕	A2C59511319	13
			276DT; → 9A000001 ; ↕	A2C59511319	13
			276DT; ↕	A2C59511319	13
LAND ROVER - DISCOVERY IV (L319) 09/09→					
Common Rail Diesel Injector					
2.7 TD 4x4	140 kW	09/09→	276DT; → AA000001	A2C59513553	17
			276DT	A2C59513553	17



					VDO	
LAND ROVER - DISCOVERY IV (L319) 09/09→						
Diesel Common Rail Pump						
2.7 TD 4x4	140 kW	09/09→	276DT; → AA000001		A2C59513482	17
			276DT		A2C59513482	17
LAND ROVER - RANGE ROVER III (L322) 03/02→12/12						
Common Rail Diesel Injector						
3.6 D 4x4	200 kW	04/06→08/12	368DT; → 7A000001		A2C59513597	19
Diesel Common Rail Pump						
3.6 D 4x4	200 kW	04/06→08/12	368DT; → 7A000001 → 8A273645		A2C59513481	16
			368DT; → 8A273646		A2C59513481	16
LAND ROVER - RANGE ROVER SPORT (L320) 02/05→03/13						
Common Rail Diesel Injector						
2.7 D 4x4	140 kW	02/05→03/13	276DT		A2C59511364	13
			276DT; → 7A000001		A2C59513553	17
3.6 D 4x4	200 kW	04/06→03/13	368DT; → 7A000001		A2C59513597	19
Diesel Common Rail Pump						
2.7 D 4x4	140 kW	02/05→03/13	276DT; → 7A000001 → 9A211714		A2C59513482	17
			276DT; → 9A211715		A2C59513482	17
			276DT; → 8A147002 → 9A211714		A2C59513482	17
			276DT; → 7A000001 → 8A147001		A2C59513482	17
3.6 D 4x4	200 kW	04/06→03/13	368DT; → 7A000001 → 8A273645		A2C59513481	16
			368DT; → 8A273646		A2C59513481	16
Distributor Pipe, fuel						
2.7 D 4x4	140 kW	02/05→03/13	276DT; Fuel Rail (V240)		A2C59511317	12
			276DT; → 8A999999; Fuel Rail (V240)		A2C59511317	12
			276DT; → 9A000001; Fuel Rail (V240)		A2C59511317	12
			276DT; → 9A000001;		A2C59511318	12
			276DT;		A2C59511318	12
			276DT; → 8A999999;		A2C59511318	12
			276DT; → 9A000001;		A2C59511319	13
			276DT; → 8A999999;		A2C59511319	13
			276DT;		A2C59511319	13
MAZDA - 3 (BL) 12/08→09/14						
Common Rail Diesel Injector						
1.6 MZR CD	85 kW	09/10→05/13	Y650 / Y655; 02/12; → BL1***532084		A2C59513556	18
Diesel Common Rail Pump						
1.6 MZR CD	85 kW	09/10→05/13	Y650 / Y655; 07/11		A2C59513829	19
MAZDA - 3 Saloon (BL) 12/08→						
Common Rail Diesel Injector						
1.6 MZR CD	85 kW	09/10→05/13	Y650 / Y655; 02/12; → BL1***532084		A2C59513556	18
Diesel Common Rail Pump						
1.6 MZR CD	85 kW	09/10→05/13	Y650 / Y655; 07/11		A2C59513829	19
MAZDA - 5 (CW) 09/10→						
Common Rail Diesel Injector						
1.6 CD	85 kW	09/10→	Y650 / Y655; 02/12; → CW*9**135367		A2C59513556	18
Diesel Common Rail Pump						
1.6 CD	85 kW	09/10→	Y650 / Y655		A2C59513829	19



MERCEDES-BENZ - A-CLASS (W176) 06/12→					
Common Rail Diesel Injector					
A 180 CDI / d (176.012)	80 kW	06/12→	OM 607.951	A2C59507596	11
Diesel Common Rail Pump					
A 180 CDI / d (176.012)	80 kW	06/12→	OM 607.951	A2C59507608	11
MERCEDES-BENZ - B-CLASS (W246, W242) 10/11→					
Common Rail Diesel Injector					
B 180 CDI / d (246.212)	80 kW	02/13→	OM 607.951	A2C59507596	11
Diesel Common Rail Pump					
B 180 CDI / d (246.212)	80 kW	02/13→	OM 607.951	A2C59507608	11
MERCEDES-BENZ - CITAN Box (415) 11/12→					
Common Rail Diesel Injector					
111 CDI (415.603, 415.605)	81 kW	06/13→	OM 607.951	A2C59507596	11
Diesel Common Rail Pump					
111 CDI (415.603, 415.605)	81 kW	06/13→	OM 607.951	A2C59507608	11
MERCEDES-BENZ - CITAN Combi (415) 11/12→					
Common Rail Diesel Injector					
111 CDI (415.703)	81 kW	06/13→	OM 607.951	A2C59507596	11
Diesel Common Rail Pump					
111 CDI (415.703)	81 kW	06/13→	OM 607.951	A2C59507608	11
MERCEDES-BENZ - CITAN Mixto (415) 11/12→					
Common Rail Diesel Injector					
111 CDI (415.601, 415.603, 415.605)	81 kW	06/13→	OM 607.951	A2C59507596	11
Diesel Common Rail Pump					
111 CDI (415.601, 415.603, 415.605)	81 kW	06/13→	OM 607.951	A2C59507608	11
MERCEDES-BENZ - CLA Coupe (C117) 01/13→					
Common Rail Diesel Injector					
CLA 180 CDI / d (117.312)	80 kW	10/13→	OM 607.951	A2C59507596	11
Diesel Common Rail Pump					
CLA 180 CDI / d (117.312)	80 kW	10/13→	OM 607.951	A2C59507608	11
MERCEDES-BENZ - CLA Shooting Brake (X117) 01/15→					
Common Rail Diesel Injector					
CLA 180 d (117.912)	80 kW	07/15→	OM 607.951	A2C59507596	11
Diesel Common Rail Pump					
CLA 180 d (117.912)	80 kW	07/15→	OM 607.951	A2C59507608	11
MERCEDES-BENZ - GLA-CLASS (X156) 12/13→					
Common Rail Diesel Injector					
GLA 180 CDI / d (156.912)	80 kW	07/14→	OM 607.951	A2C59507596	11



				VDO	
MERCEDES-BENZ - GLA-CLASS (X156) 12/13→					
Diesel Common Rail Pump					
GLA 180 CDI / d (156.912)	80 kW	07/14→	OM 607.951	A2C59507608	11
NISSAN - CUBE (Z12) 09/07→					
Common Rail Diesel Injector					
1.5 dCi	81 kW	03/10→		A2C59513484	17
Diesel Common Rail Pump					
1.5 dCi	81 kW	03/10→		A2C59513595	18
NISSAN - JUKE (F15) 06/10→					
Common Rail Diesel Injector					
1.5 dCi	81 kW	06/10→	K9K 636	A2C59507596	11
			K9K 896	A2C59513484	17
Diesel Common Rail Pump					
1.5 dCi	81 kW	06/10→	K9K 636	A2C59507608	11
			K9K 896	A2C59513595	18
NISSAN - NOTE (E11, NE11) 01/05→08/13					
Common Rail Diesel Injector					
1.5 dCi	76 kW	07/08→06/12		A2C59511606	15
Diesel Common Rail Pump					
1.5 dCi	76 kW	07/08→06/12		A2C59511605	15
NISSAN - NV200 / EVALIA Bus 07/10→					
Common Rail Diesel Injector					
1.5 dci (M20, M20M)	81 kW	04/11→	K9K 636 / K9K 646	A2C59507596	11
Diesel Common Rail Pump					
1.5 dci (M20, M20M)	81 kW	04/11→	K9K 636 / K9K 646	A2C59507608	11
NISSAN - NV200 Box Body / Estate 02/10→					
Common Rail Diesel Injector					
1.5 dci (M20, M20M)	81 kW	04/11→	K9K 636 / K9K 646	A2C59507596	11
Diesel Common Rail Pump					
1.5 dci (M20, M20M)	81 kW	04/11→	K9K 636 / K9K 646	A2C59507608	11
NISSAN - QASHQAI / QASHQAI +2 I (J10, NJ10) 12/06→04/14					
Common Rail Diesel Injector					
1.5 dCi	78 kW	02/07→12/13		A2C59511606	15
1.5 dCi	81 kW	01/10→12/13		A2C59513484	17
Diesel Common Rail Pump					
1.5 dCi	78 kW	02/07→12/13		A2C59511605	15
1.5 dCi	81 kW	01/10→12/13	K9K 430	A2C59513595	18
NISSAN - QASHQAI II Closed Off-Road Vehicle (J11, J11_) 11/13→					
Common Rail Diesel Injector					
1.5 dCi	81 kW	11/13→	K9K 636	A2C59507596	11
Diesel Common Rail Pump					
1.5 dCi	81 kW	11/13→	K9K 636	A2C59507608	11



NISSAN - TIIDA Hatchback (C11) 05/04→12/13					
Common Rail Diesel Injector					
1.5 dCi	78 kW	09/07→12/11		A2C59511606	15
Diesel Common Rail Pump					
1.5 dCi	78 kW	09/07→12/11		A2C59511605	15
NISSAN - TIIDA Saloon (SC11) 05/04→12/13					
Common Rail Diesel Injector					
1.5 dCi	78 kW	09/07→12/12		A2C59511606	15
Diesel Common Rail Pump					
1.5 dCi	78 kW	09/07→12/12		A2C59511605	15
PEUGEOT - 107 06/05→					
Common Rail Diesel Injector					
1.4 HDi	40 kW	06/05→05/14	8HT (DV4TD)	A2C59511612	16
PEUGEOT - 207 CC (WD_) 02/07→					
Common Rail Diesel Injector					
1.6 HDi	82 kW	08/09→	9HR (DV6C); 12/11	A2C59513556	18
			9HR (DV6C); 03/10	A2C59513556	18
Diesel Common Rail Pump					
1.6 HDi	82 kW	08/09→	9HR (DV6C); 07/10	A2C59513830	19
			9HR (DV6C); 06/10	A2C59513830	19
PEUGEOT - 207 SW (WK_) 02/07→					
Common Rail Diesel Injector					
1.6 HDi	82 kW	08/09→	9HR (DV6C); 12/11	A2C59513556	18
			9HR (DV6C); 03/10	A2C59513556	18
			9HR (DV6C); 03/10 12/11	A2C59513556	18
Diesel Common Rail Pump					
1.6 HDi	82 kW	08/09→	9HR (DV6C); 07/10	A2C59513830	19
			9HR (DV6C); 06/10	A2C59513830	19
PEUGEOT - 208 (CA_, CC_) 03/12→					
Common Rail Diesel Injector					
1.6 HDi	84 kW	03/12→		A2C59513556	18
Diesel Common Rail Pump					
1.6 HDi	84 kW	03/12→		A2C59513830	19
PEUGEOT - 307 (3A/C) 08/00→04/12					
Common Rail Diesel Injector					
2.0 HDi 135	100 kW	10/03→11/07	RHR (DW10BTED4); Version (C2): Class 4	5WS40156-4Z	9
			RHR (DW10BTED4); Version (C2): Class 5	5WS40156-Z	9
			RHR (DW10BTED4); Version (C2): Class 6	A2C59511601	14
			RHR (DW10BTED4); Version (C2): Class M	A2C59511603	14
2.0 HDi 90	66 kW	08/00→03/07	RHY (DW10TD)	5WS40000-Z	8
Diesel Common Rail Pump					
2.0 HDi 135	100 kW	10/03→11/07	RHR (DW10BTED4)	5WS40809-Z	10
2.0 HDi 90	66 kW	08/00→03/07	RHY (DW10TD)	5WS40018-Z	8



VDO

**PEUGEOT - 307 Break (3E) 03/02→12/09****Common Rail Diesel Injector**

2.0 HDi 135	100 kW	02/04→04/08	RHR (DW10BTED4); Version (C2): Class 4	5WS40156-4Z	9
			RHR (DW10BTED4); Version (C2): Class 5	5WS40156-Z	9
			RHR (DW10BTED4); Version (C2): Class 6	A2C59511601	14
			RHR (DW10BTED4); Version (C2): Class M	A2C59511603	14
2.0 HDi 90	66 kW	03/02→04/08	RHY (DW10TD)	5WS40000-Z	8

**Diesel Common Rail Pump**

2.0 HDi 135	100 kW	02/04→04/08	RHR (DW10BTED4)	5WS40809-Z	10
2.0 HDi 90	66 kW	03/02→04/08	RHY (DW10TD)	5WS40018-Z	8

PEUGEOT - 307 CC (3B) 03/03→06/09**Common Rail Diesel Injector**

2.0 HDi 135	100 kW	06/05→04/09	RHR (DW10BTED4); Version (C2): Class 4	5WS40156-4Z	9
			RHR (DW10BTED4); Version (C2): Class 5	5WS40156-Z	9
			RHR (DW10BTED4); Version (C2): Class 6	A2C59511601	14
			RHR (DW10BTED4); Version (C2): Class M	A2C59511603	14

**Diesel Common Rail Pump**

2.0 HDi 135	100 kW	06/05→04/09	RHR (DW10BTED4)	5WS40809-Z	10
-------------	--------	-------------	-----------------	-------------------	----

PEUGEOT - 307 SW (3H) 03/02→12/09**Common Rail Diesel Injector**

2.0 HDi 135	100 kW	02/04→04/08	RHR (DW10BTED4); Version (C2): Class 4	5WS40156-4Z	9
			RHR (DW10BTED4); Version (C2): Class 5	5WS40156-Z	9
			RHR (DW10BTED4); Version (C2): Class 6	A2C59511601	14
			RHR (DW10BTED4); Version (C2): Class M	A2C59511603	14
2.0 HDi 90	66 kW	03/02→04/08	RHY (DW10TD)	5WS40000-Z	8

**Diesel Common Rail Pump**

2.0 HDi 135	100 kW	02/04→04/08	RHR (DW10BTED4)	5WS40809-Z	10
2.0 HDi 90	66 kW	03/02→04/08	RHY (DW10TD)	5WS40018-Z	8

PEUGEOT - 308 (4A_, 4C_) 09/07→**Common Rail Diesel Injector**

1.6 HDi	66 kW	09/07→	12/11	A2C59513556	18
			12/11	A2C59513556	18
			03/10	A2C59513556	18
			03/10 12/11	A2C59513556	18
1.6 HDi	82 kW	12/09→	9HR (DV6C); 12/11	A2C59513556	18
			9HR (DV6C); 12/11	A2C59513556	18
			9HR (DV6C); 03/10 12/11	A2C59513556	18
			9HR (DV6C); 03/10	A2C59513556	18
1.6 HDi	84 kW	03/13→		A2C59513556	18

**Diesel Common Rail Pump**

1.6 HDi	66 kW	09/07→	07/10	A2C59513830	19
			06/10	A2C59513830	19
1.6 HDi	82 kW	12/09→	9HR (DV6C); 06/10	A2C59513830	19
			9HR (DV6C); 07/10	A2C59513830	19
1.6 HDi	84 kW	03/13→		A2C59513830	19

PEUGEOT - 308 II 09/13→**Common Rail Diesel Injector**

1.6 HDi	68 kW	09/13→		A2C59513556	18
1.6 HDi / BlueHDi 115	85 kW	09/13→			

**Diesel Common Rail Pump**

1.6 HDi	68 kW	09/13→		A2C59513830	19
1.6 HDi / BlueHDi 115	85 kW	09/13→			



PEUGEOT - 308 CC (4B_) 02/09→					
Common Rail Diesel Injector					
1.6 HDi	82 kW	06/09→	9HR (DV6C); 12/11 9HR (DV6C); 12/11 9HR (DV6C); 03/10 12/11 9HR (DV6C); 03/10	A2C59513556 A2C59513556 A2C59513556 A2C59513556	18 18 18 18
1.6 HDi	84 kW	03/13→		A2C59513556	18
Diesel Common Rail Pump					
1.6 HDi	82 kW	06/09→	9HR (DV6C); 07/10 9HR (DV6C); 06/10	A2C59513830 A2C59513830	19 19
1.6 HDi	84 kW	03/13→		A2C59513830	19
PEUGEOT - 308 SW (4E_, 4H_) 09/07→					
Common Rail Diesel Injector					
1.6 HDi	82 kW	12/09→	9HR (DV6C); 12/11 9HR (DV6C); 12/11 9HR (DV6C); 03/10 12/11 9HR (DV6C); 03/10	A2C59513556 A2C59513556 A2C59513556 A2C59513556	18 18 18 18
1.6 HDi	84 kW	03/13→03/17		A2C59513556	18
Diesel Common Rail Pump					
1.6 HDi	82 kW	12/09→	9HR (DV6C); 07/10	A2C59513830	19
1.6 HDi	84 kW	03/13→03/17		A2C59513830	19
PEUGEOT - 406 (8B) 08/95→01/05					
Common Rail Diesel Injector					
2.0 HDi 90	66 kW	02/99→05/04	RHY (DW10TD)	5WS40000-Z	8
Diesel Common Rail Pump					
2.0 HDi 90	66 kW	02/99→05/04	RHY (DW10TD)	5WS40018-Z	8
PEUGEOT - 406 Break (8E/F) 10/96→10/04					
Common Rail Diesel Injector					
2.0 HDi 90	66 kW	02/99→10/04	RHY (DW10TD)	5WS40000-Z	8
Diesel Common Rail Pump					
2.0 HDi 90	66 kW	02/99→10/04	RHY (DW10TD)	5WS40018-Z	8
PEUGEOT - 407 (6D_) 03/04→					
Common Rail Diesel Injector					
2.0 HDi	103 kW	06/09→12/10	RHF (DW10BTED4); Version (C2): Class 4 RHR (DW10BTED4) RHF (DW10BTED4); Version (C2): Class 6 RHF (DW10BTED4); RPO number from (C57): 10766	5WS40156-4Z 5WS40156-Z A2C59511601 A2C59511603	9 9 14 14
2.0 HDi 135	100 kW	05/04→	RHR (DW10BTED4); Version (C2): Class 4 RHR (DW10BTED4); Version (C2): Class 5 RHR (DW10BTED4); Version (C2): Class 6 RHR (DW10BTED4); RPO number from (C57): 10766	5WS40156-4Z 5WS40156-Z A2C59511601 A2C59511603	9 9 14 14
2.7 HDi	150 kW	10/05→	UHZ (DT17)	A2C59511316	12
Diesel Common Rail Pump					
2.0 HDi	103 kW	06/09→12/10	RHR (DW10BTED4)	5WS40809-Z	10
2.0 HDi 135	100 kW	05/04→			
Distributor Pipe, fuel					
2.7 HDi	150 kW	10/05→	UHZ (DT17); Fuel Rail (V240) UHZ (DT17); UHZ (DT17);	A2C59511317 A2C59511318 A2C59511319	12 12 13



					VDO	
PEUGEOT - 407 Coupe (6C_) 10/05→						
Common Rail Diesel Injector						
2.0 HDi	100 kW	10/05→		RHR (DW10BTED4); Version (C2): Class 4	5WS40156-4Z	9
				RHR (DW10BTED4); Version (C2): Class 5	5WS40156-Z	9
				RHR (DW10BTED4); Version (C2): Class 6	A2C59511601	14
				RHR (DW10BTED4); RPO number from (C57): 10766	A2C59511603	14
2.7 HDi	150 kW	10/05→		UHZ (DT17)	A2C59511316	12
Diesel Common Rail Pump						
2.0 HDi	100 kW	10/05→		RHR (DW10BTED4)	5WS40809-Z	10
Distributor Pipe, fuel						
2.7 HDi	150 kW	10/05→		UHZ (DT17); ↕ Fuel Rail (V240)	A2C59511317	12
				UHZ (DT17); ↕	A2C59511318	12
				UHZ (DT17); ↕	A2C59511319	13
PEUGEOT - 407 SW (6E_) 05/04→						
Common Rail Diesel Injector						
2.0 HDi	103 kW	08/08→		RHR (DW10BTED4); Version (C2): Class 4	5WS40156-4Z	9
2.0 HDi 135	100 kW	07/04→12/10		RHR (DW10BTED4); Version (C2): Class 5	5WS40156-Z	9
				RHR (DW10BTED4); Version (C2): Class 6	A2C59511601	14
				RHR (DW10BTED4); RPO number from (C57): 10766	A2C59511603	14
2.7 HDi	150 kW	10/05→		UHZ (DT17)	A2C59511316	12
Diesel Common Rail Pump						
2.0 HDi	103 kW	08/08→		RHR (DW10BTED4)	5WS40809-Z	10
2.0 HDi 135	100 kW	07/04→12/10				
Distributor Pipe, fuel						
2.7 HDi	150 kW	10/05→		UHZ (DT17); ↕ Fuel Rail (V240)	A2C59511317	12
				UHZ (DT17); ↕	A2C59511318	12
				UHZ (DT17); ↕	A2C59511319	13
PEUGEOT - 508 I (8D_) 11/10→						
Common Rail Diesel Injector						
1.6 HDi	82 kW	11/10→		9HR (DV6C); 12/11	A2C59513556	18
1.6 HDi	84 kW	02/12→		9HD (DV6CTED)	A2C59513556	18
Diesel Common Rail Pump						
1.6 HDi	82 kW	11/10→		9HR (DV6C)	A2C59513830	19
1.6 HDi	84 kW	02/12→		9HD (DV6CTED)	A2C59513830	19
PEUGEOT - 508 SW I (8E_) 11/10→						
Common Rail Diesel Injector						
1.6 HDi	82 kW	11/10→		9HR (DV6C); 12/11	A2C59513556	18
				9HR (DV6C); 12/11	A2C59513556	18
1.6 HDi	84 kW	02/12→		9HD (DV6CTED)	A2C59513556	18
Diesel Common Rail Pump						
1.6 HDi	82 kW	11/10→		9HR (DV6C)	A2C59513830	19
1.6 HDi	84 kW	02/12→		9HD (DV6CTED)	A2C59513830	19
PEUGEOT - 607 (9D, 9U) 01/00→						
Common Rail Diesel Injector						
2.0 HDi	100 kW	09/05→07/11		RHR (DW10BTED4)	5WS40156-Z	9
2.7 HDi 24V	150 kW	12/04→07/11		DT17TED4	A2C59511316	12
Diesel Common Rail Pump						
2.0 HDi	100 kW	09/05→07/11		RHR (DW10BTED4)	5WS40809-Z	10
Distributor Pipe, fuel						
2.7 HDi 24V	150 kW	12/04→07/11		DT17TED4; ↕ Fuel Rail (V240)	A2C59511317	12
				DT17TED4; ↕	A2C59511318	12
				DT17TED4; ↕	A2C59511319	13



VDO

PEUGEOT - 807 (E) 06/02→

Common Rail Diesel Injector

2.0 HDi	88 kW	02/06→		A2C59511602	14
2.0 HDi	100 kW	06/06→	RHR (DW10BTED4); Version (C2): Class 4	5WS40156-4Z	9
			RHR (DW10BTED4); Version (C2): Class 5	5WS40156-Z	9
			RHR (DW10BTED4); Version (C2): Class 6	A2C59511601	14

Diesel Common Rail Pump

2.0 HDi	88 kW	02/06→		5WS40809-Z	10
2.0 HDi	100 kW	06/06→	RHR (DW10BTED4)	5WS40809-Z	10

PEUGEOT - 1007 (KM_) 04/05→

Common Rail Diesel Injector

1.4 HDi	50 kW	04/05→	8HX (DV4TD)	5WS40148-Z	8
			8HZ (DV4TD)	A2C59511612	16

PEUGEOT - 2008 (CU_) 03/13→

Common Rail Diesel Injector

1.6 HDi	84 kW	03/13→	9HD (DV6CTED)	A2C59513556	18
---------	-------	--------	---------------	--------------------	----

Diesel Common Rail Pump

1.6 HDi	84 kW	03/13→	9HD (DV6CTED)	A2C59513830	19
---------	-------	--------	---------------	--------------------	----

PEUGEOT - 3008 MPV (0U_) 06/09→12/16

Common Rail Diesel Injector

1.6 HDi	80 kW	06/09→08/16	9HZ (DV6TED4); 07/10	A2C59513556	18
			9HZ (DV6TED4); 06/10	A2C59513556	18
1.6 HDi	82 kW	12/09→08/16	9HR (DV6C); 12/11	A2C59513556	18
			9HR (DV6C); 12/11	A2C59513556	18
1.6 HDi	84 kW	03/13→08/16	9HD (DV6CTED)	A2C59513556	18

Diesel Common Rail Pump

1.6 HDi	80 kW	06/09→08/16	9HZ (DV6TED4); 07/10	A2C59513830	19
			9HZ (DV6TED4); 06/10	A2C59513830	19
1.6 HDi	82 kW	12/09→08/16	9HR (DV6C)	A2C59513830	19
1.6 HDi	84 kW	03/13→08/16	9HD (DV6CTED)	A2C59513830	19

PEUGEOT - 4008 05/12→

Common Rail Diesel Injector

1.6 HDi AWC	84 kW	05/12→		A2C59513556	18
-------------	-------	--------	--	--------------------	----

Diesel Common Rail Pump

1.6 HDi AWC	84 kW	05/12→		A2C59513830	19
-------------	-------	--------	--	--------------------	----

PEUGEOT - 5008 (0U_, 0E_) 06/09→

Common Rail Diesel Injector

1.6 HDi	80 kW	09/09→	9HZ (DV6TED4); 07/10	A2C59513556	18
			9HZ (DV6TED4); 06/10	A2C59513556	18
1.6 HDi	82 kW	08/10→	9HR (DV6C); 12/11	A2C59513556	18
			9HR (DV6C); 12/11	A2C59513556	18
1.6 HDi	84 kW	03/13→	9HD (DV6CTED)	A2C59513556	18

Diesel Common Rail Pump

1.6 HDi	80 kW	09/09→	9HZ (DV6TED4); 07/10	A2C59513830	19
			9HZ (DV6TED4); 06/10	A2C59513830	19
1.6 HDi	82 kW	08/10→	9HR (DV6C)	A2C59513830	19
1.6 HDi	84 kW	03/13→	9HD (DV6CTED)	A2C59513830	19



VDO

**PEUGEOT - BOXER Box 04/06** →**Common Rail Diesel Injector**

2.0 BlueHDi 110	81 kW	07/15→		A2C59517051	21
2.0 BlueHDi 130	96 kW	07/15→	AHN (DW10FUD)	A2C59517051	21
2.2 HDi 110	81 kW	03/11→		A2C59517051	21
2.2 HDi 130	96 kW	03/11→			
2.2 HDi 150	110 kW	03/11→			

**Diesel Common Rail Pump**

2.2 HDi 110	81 kW	03/11→		A2C59517045	20
2.2 HDi 130	96 kW	03/11→			
2.2 HDi 150	110 kW	03/11→			

PEUGEOT - BOXER Bus 09/05 →**Common Rail Diesel Injector**

2.0 BlueHDi 110	81 kW	07/15→		A2C59517051	21
2.0 BlueHDi 130	96 kW	07/15→	AHN (DW10FUD)	A2C59517051	21
2.2 HDi 110	81 kW	03/11→		A2C59517051	21
2.2 HDi 130	96 kW	03/11→			
2.2 HDi 150	110 kW	03/11→			

**Diesel Common Rail Pump**

2.2 HDi 110	81 kW	03/11→		A2C59517045	20
2.2 HDi 130	96 kW	03/11→			
2.2 HDi 150	110 kW	03/11→			

PEUGEOT - BOXER Platform/Chassis 04/06 →**Common Rail Diesel Injector**

2.0 BlueHDi 110	81 kW	07/15→		A2C59517051	21
2.0 BlueHDi 130	96 kW	07/15→	AHN (DW10FUD)	A2C59517051	21
2.2 HDi 110	81 kW	03/11→		A2C59517051	21
2.2 HDi 130	96 kW	03/11→			
2.2 HDi 150	110 kW	03/11→			

**Diesel Common Rail Pump**

2.2 HDi 110	81 kW	03/11→		A2C59517045	20
2.2 HDi 130	96 kW	03/11→			
2.2 HDi 150	110 kW	03/11→			

PEUGEOT - EXPERT Box (VF3A_, VF3U_, VF3X_) 01/07 →**Common Rail Diesel Injector**

2.0 HDi 120	88 kW	01/07→		A2C59511602	14
2.0 HDi 140	100 kW	01/07→	RHR (DW10BTED4); Version (C2): Class 4	5WS40156-4Z	9
			RHR (DW10BTED4); Version (C2): Class 5	5WS40156-Z	9
			RHR (DW10BTED4); Version (C2): Class 6	A2C59511601	14

**Diesel Common Rail Pump**

2.0 HDi 120	88 kW	01/07→		5WS40809-Z	10
2.0 HDi 140	100 kW	01/07→	RHR (DW10BTED4)	5WS40809-Z	10

PEUGEOT - EXPERT Platform/Chassis 01/07 →**Common Rail Diesel Injector**

2.0 HDi 120	88 kW	01/07→		A2C59511602	14
2.0 HDi 140	100 kW	01/07→	RHR (DW10BTED4); Version (C2): Class 4	5WS40156-4Z	9
			RHR (DW10BTED4); Version (C2): Class 5	5WS40156-Z	9
			RHR (DW10BTED4); Version (C2): Class 6	A2C59511601	14

**Diesel Common Rail Pump**

2.0 HDi 120	88 kW	01/07→		5WS40809-Z	10
2.0 HDi 140	100 kW	01/07→	RHR (DW10BTED4)	5WS40809-Z	10



VDO

PEUGEOT - EXPERT Tepee (VF3X_) 01/07→

Common Rail Diesel Injector				
2.0 HDi 120	88 kW	01/07→		A2C59511602 14
2.0 HDi 120 4x4	88 kW	01/07→		
2.0 HDi 140	100 kW	01/07→	RHR (DW10BTED4); Version (C2): Class 4	5WS40156-4Z 9
			RHR (DW10BTED4); Version (C2): Class 5	5WS40156-Z 9
			RHR (DW10BTED4); Version (C2): Class 6	A2C59511601 14

Diesel Common Rail Pump				
2.0 HDi 120	88 kW	01/07→		5WS40809-Z 10
2.0 HDi 120 4x4	88 kW	01/07→		
2.0 HDi 140	100 kW	01/07→	RHR (DW10BTED4)	5WS40809-Z 10

PEUGEOT - PARTNER Box 04/08→

Common Rail Diesel Injector				
1.6 HDi	84 kW	03/13→	9HL (DV6C)	A2C59513556 18
1.6 HDi 90	68 kW	04/10→	12/11	A2C59513556 18
			12/11	A2C59513556 18

Diesel Common Rail Pump				
1.6 HDi	84 kW	03/13→	9HL (DV6C)	A2C59513830 19
1.6 HDi 90	68 kW	04/10→	07/10	A2C59513830 19

PEUGEOT - PARTNER Box (5) 04/96→12/15

Common Rail Diesel Injector				
2.0 HDi	66 kW	04/00→07/08	RHY (DW10TD)	5WS40000-Z 8
2.0 HDi 4x4	66 kW	04/04→08/05		

Diesel Common Rail Pump				
2.0 HDi	66 kW	04/00→07/08	RHY (DW10TD)	5WS40018-Z 8
2.0 HDi 4x4	66 kW	04/04→08/05		

PEUGEOT - PARTNER Combispace (5F) 05/96→12/15

Common Rail Diesel Injector				
2.0 HDi	66 kW	02/00→07/08	RHY (DW10TD)	5WS40000-Z 8
2.0 HDi 4x4	66 kW	04/04→08/05		

Diesel Common Rail Pump				
2.0 HDi	66 kW	02/00→07/08	RHY (DW10TD)	5WS40018-Z 8
2.0 HDi 4x4	66 kW	04/04→08/05		

PEUGEOT - PARTNER Tepee 04/08→

Common Rail Diesel Injector				
1.6 HDi	82 kW	08/10→	12/11	A2C59513556 18
			12/11	A2C59513556 18
1.6 HDi	84 kW	03/13→	9HL (DV6C)	A2C59513556 18

Diesel Common Rail Pump				
1.6 HDi	82 kW	08/10→		A2C59513830 19
1.6 HDi	84 kW	03/13→	9HL (DV6C)	A2C59513830 19

RENAULT - CAPTUR (J5_, H5_) 06/13→

Common Rail Diesel Injector				
1.5 dCi 110	81 kW	01/15→	K9K 646	A2C59507596 11

Diesel Common Rail Pump				
1.5 dCi 110	81 kW	01/15→	K9K 646	A2C59507608 11



VDO

**RENAULT - CLIO III (BR0/1, CR0/1) 01/05→****Common Rail Diesel Injector**

1.5 dCi (BR0H, CR0H, CR1S, BR1S)	78 kW	06/05→	K9K 764	A2C59511606	15
			K9K 774	A2C59513484	17
1.5 dCi (BR1C, CR1C)	76 kW	06/05→	K9K 772	A2C59511606	15

**Diesel Common Rail Pump**

1.5 dCi (BR0H, CR0H, CR1S, BR1S)	78 kW	06/05→	K9K 764	A2C59511605	15
			K9K 774	A2C59513595	18
1.5 dCi (BR1C, CR1C)	76 kW	06/05→	K9K 772	A2C59511605	15

RENAULT - CLIO Grandtour (KR0/1_) 02/08→**Common Rail Diesel Injector**

1.5 dCi	65 kW	08/10→	K9K 772	A2C59511606	15
1.5 dCi (KR0H, KR1S)	78 kW	02/08→12/12	K9K 764	A2C59511606	15
			K9K 774	A2C59513484	17
1.5 dCi (KR1C, KR1N)	76 kW	02/08→	K9K 772	A2C59511606	15

**Diesel Common Rail Pump**

1.5 dCi	65 kW	08/10→	K9K 772	A2C59511605	15
1.5 dCi (KR0H, KR1S)	78 kW	02/08→12/12	K9K 764	A2C59511605	15
			K9K 774	A2C59513595	18
1.5 dCi (KR1C, KR1N)	76 kW	02/08→	K9K 772	A2C59511605	15

RENAULT - FLUENCE (L3_) 02/10→**Common Rail Diesel Injector**

1.5 dCi	70 kW	07/14→	K9K 826	A2C59513484	17
1.5 dCi (L30B)	78 kW	02/10→	K9K 832	A2C59513484	17
1.5 dCi (L30D, L30L, L306, L33F, L33L, L33M, L33V, L33W)	81 kW	02/10→	K9K 836 / K9K 837	A2C59513484	17
				A2C59513484	17

**Diesel Common Rail Pump**

1.5 dCi	70 kW	07/14→	K9K 826	A2C59513595	18
1.5 dCi (L30B)	78 kW	02/10→	K9K 832	A2C59513595	18
1.5 dCi (L30D, L30L, L306, L33F, L33L, L33M, L33V, L33W)	81 kW	02/10→	K9K 836 / K9K 837	A2C59513595	18

RENAULT - GRAND SCÉNIC III (JZ0/1_) 02/09→**Common Rail Diesel Injector**

1.5 dCi	70 kW	11/10→	K9K 846	A2C59513484	17
1.5 dCi	78 kW	02/09→	K9K 832	A2C59513484	17
1.5 dCi	81 kW	04/09→	K9K 636	A2C59507596	11
			K9K 836 / K9K 837	A2C59513484	17

**Diesel Common Rail Pump**

1.5 dCi	70 kW	11/10→	K9K 846	A2C59513595	18
1.5 dCi	78 kW	02/09→	K9K 832	A2C59513595	18
1.5 dCi	81 kW	04/09→	K9K 636	A2C59507608	11
			K9K 836 / K9K 837	A2C59513595	18

RENAULT - KADJAR (HA_, HL_) 06/15→**Common Rail Diesel Injector**

1.5 dCi 110	81 kW	06/15→	K9K 646 / K9K 647	A2C59507596	11
-------------	-------	--------	-------------------	--------------------	----

**Diesel Common Rail Pump**

1.5 dCi 110	81 kW	06/15→	K9K 646 / K9K 647	A2C59507608	11
-------------	-------	--------	-------------------	--------------------	----



VDO

RENAULT - KANGOO / GRAND KANGOO (KW0/1_) 02/08→

Common Rail Diesel Injector

1.5 dCi (KW0F)	76 kW	02/08→	K9K 806	A2C59511606	15
			K9K 804	A2C59511606	15
1.5 dCi 110	80 kW	09/10→	K9K 804	A2C59511606	15
1.5 dCi 110	81 kW	03/13→	K9K 636	A2C59507596	11

Diesel Common Rail Pump

1.5 dCi (KW0F)	76 kW	02/08→	K9K 806	A2C59511605	15
			K9K 804	A2C59511605	15
1.5 dCi 110	80 kW	09/10→	K9K 804	A2C59511605	15
1.5 dCi 110	81 kW	03/13→	K9K 636	A2C59507608	11

RENAULT - KANGOO BE BOP (KW0/1_) 02/09→

Common Rail Diesel Injector

1.5 dCi	80 kW	06/09→	K9K 804	A2C59511606	15
1.5 dCi (KW0F)	76 kW	02/09→	K9K 806	A2C59511606	15

Diesel Common Rail Pump

1.5 dCi	80 kW	06/09→	K9K 804	A2C59511605	15
1.5 dCi (KW0F)	76 kW	02/09→	K9K 806	A2C59511605	15

RENAULT - KANGOO Express (FW0/1_) 02/08→

Common Rail Diesel Injector

1.5 dCi (FW0F)	76 kW	02/08→	K9K 806	A2C59511606	15
1.5 dCi 110	80 kW	09/10→	K9K 804	A2C59511606	15
1.5 dCi 110	81 kW	09/13→	K9K 636	A2C59507596	11

Diesel Common Rail Pump

1.5 dCi (FW0F)	76 kW	02/08→	K9K 806	A2C59511605	15
1.5 dCi 110	80 kW	09/10→	K9K 804	A2C59511605	15
1.5 dCi 110	81 kW	09/13→	K9K 636	A2C59507608	11

RENAULT - LAGUNA III (BT0/1) 10/07→12/15

Common Rail Diesel Injector

1.5 dCi (BT00, BT0A, BT0T, BT1J)	81 kW	10/07→12/15	K9K 780	A2C59511606	15
----------------------------------	-------	-------------	---------	--------------------	----

Diesel Common Rail Pump

1.5 dCi (BT00, BT0A, BT0T, BT1J)	81 kW	10/07→12/15	K9K 780	A2C59511605	15
----------------------------------	-------	-------------	---------	--------------------	----

RENAULT - LAGUNA III Grandtour (KT0/1) 10/07→12/15

Common Rail Diesel Injector

1.5 dCi (KT0A)	81 kW	10/07→12/15	K9K 780	A2C59511606	15
----------------	-------	-------------	---------	--------------------	----

Diesel Common Rail Pump

1.5 dCi (KT0A)	81 kW	10/07→12/15	K9K 780	A2C59511605	15
----------------	-------	-------------	---------	--------------------	----

RENAULT - LAGUNA Coupe (DT0/1) 09/08→12/15

Common Rail Diesel Injector

1.5 dCi	81 kW	03/12→12/15	K9K 846	A2C59513484	17
---------	-------	-------------	---------	--------------------	----

Diesel Common Rail Pump

1.5 dCi	81 kW	03/12→12/15	K9K 846	A2C59513595	18
---------	-------	-------------	---------	--------------------	----

RENAULT - LATITUDE (L70_) 07/10→

Common Rail Diesel Injector

1.5 dCi (L70R)	81 kW	07/10→	K9K 782	A2C59513484	17
----------------	-------	--------	---------	--------------------	----



     					
RENAULT - LATITUDE (L70_) 07/10→					
 Diesel Common Rail Pump					
1.5 dCi (L70R)	81 kW	07/10→	 K9K 782	A2C59513595	18
RENAULT - MEGANE II (BM0/1_, CM0/1_) 07/01→10/12					
 Common Rail Diesel Injector					
1.5 dCi (BM16, CM16)	76 kW	01/07→03/09	 K9K 734	A2C59511606	15
1.5 dCi (BM1E, CM1E)	78 kW	05/05→06/08			
 Diesel Common Rail Pump					
1.5 dCi (BM16, CM16)	76 kW	01/07→03/09	 K9K 734	A2C59511605	15
1.5 dCi (BM1E, CM1E)	78 kW	05/05→06/08			
RENAULT - MEGANE II Coupé-Cabriolet (EM0/1_) 09/03→03/10					
 Common Rail Diesel Injector					
1.5 dCi (EM16)	76 kW	01/07→06/09	 K9K 734	A2C59511606	15
 Diesel Common Rail Pump					
1.5 dCi (EM16)	76 kW	01/07→06/09	 K9K 734	A2C59511605	15
RENAULT - MEGANE II Estate (KM0/1_) 08/03→08/12					
 Common Rail Diesel Injector					
1.5 dCi (KM16, KM1E)	78 kW	05/05→06/08	 K9K 734	A2C59511606	15
 Diesel Common Rail Pump					
1.5 dCi (KM16, KM1E)	78 kW	05/05→06/08	 K9K 734	A2C59511605	15
RENAULT - MEGANE II Saloon (LM0/1_) 08/03→					
 Common Rail Diesel Injector					
1.5 dCi (LM16)	76 kW	10/03→12/10	 K9K 734	A2C59511606	15
 Diesel Common Rail Pump					
1.5 dCi (LM16)	76 kW	10/03→12/10	 K9K 734	A2C59511605	15
RENAULT - MEGANE III Coupe (DZ0/1_) 11/08→					
 Common Rail Diesel Injector					
1.5 dCi	70 kW	07/14→	 K9K 846	A2C59513484	17
1.5 dCi (DZ09, DZ0D, DZ1F, DZ1G)	81 kW	02/09→	 K9K J 836 / K9K 837	A2C59513484	17
 Diesel Common Rail Pump					
1.5 dCi	70 kW	07/14→	 K9K 846	A2C59513595	18
1.5 dCi (DZ09, DZ0D, DZ1F, DZ1G)	81 kW	02/09→	 K9K J 836 / K9K 837	A2C59513595	18
RENAULT - MEGANE III Grandtour (KZ0/1) 11/08→					
 Common Rail Diesel Injector					
1.5 dCi	70 kW	11/13→	 K9K 846	A2C59513484	17
1.5 dCi (KZ09, KZ0D, KZ1G)	81 kW	02/09→	 K9K 636	A2C59507596	11
			 K9K 836 / K9K 837 / K9K 846	A2C59513484	17
1.5 dCi (KZ1M, KZ1W)	78 kW	02/09→	 K9K 836 / K9K 846	A2C59513484	17
 Diesel Common Rail Pump					
1.5 dCi	70 kW	11/13→	 K9K 846	A2C59513595	18
1.5 dCi (KZ09, KZ0D, KZ1G)	81 kW	02/09→	 K9K 636	A2C59507608	11
			 K9K 836 / K9K 837 / K9K 846	A2C59513595	18
1.5 dCi (KZ1M, KZ1W)	78 kW	02/09→	 K9K 836 / K9K 846	A2C59513595	18



VDO

RENAULT - MEGANE III Hatchback (BZ0/1_) 11/08→

Common Rail Diesel Injector

1.5 dCi (BZ09, BZ0D)	81 kW	02/09→	K9K 636	A2C59507596	11
			K9K 836 / K9K 837 / K9K 846	A2C59513484	17
1.5 dCi (BZ1G, BZ1W, BZ0R)	70 kW	11/13→	K9K 846	A2C59513484	17

Diesel Common Rail Pump

1.5 dCi (BZ09, BZ0D)	81 kW	02/09→	K9K 636	A2C59507608	11
			K9K 836 / K9K 837 / K9K 846	A2C59513595	18
1.5 dCi (BZ1G, BZ1W, BZ0R)	70 kW	11/13→	K9K 846	A2C59513595	18

RENAULT - MEGANE CC (EZ0/1_) 06/10→

Common Rail Diesel Injector

1.5 dCi (EZ09, EZ1G, EZ0D)	81 kW	06/10→	K9K 836	A2C59513484	17
----------------------------	-------	--------	---------	--------------------	----

Diesel Common Rail Pump

1.5 dCi (EZ09, EZ1G, EZ0D)	81 kW	06/10→	K9K 836	A2C59513595	18
----------------------------	-------	--------	---------	--------------------	----

RENAULT - MODUS / GRAND MODUS (F/JP0_) 09/04→

Common Rail Diesel Injector

1.5 dCi (JP02)	76 kW	05/07→	K9K 772	A2C59511606	15
1.5 dCi (JP0G, JP0H)	78 kW	05/05→	K9K 764	A2C59511606	15

Diesel Common Rail Pump

1.5 dCi (JP02)	76 kW	05/07→	K9K 772	A2C59511605	15
1.5 dCi (JP0G, JP0H)	78 kW	05/05→	K9K 764	A2C59511605	15

RENAULT - SCÉNIC II (JM0/1_) 06/03→

Common Rail Diesel Injector

1.5 dCi (JM16)	76 kW	01/07→	K9K 734	A2C59511606	15
----------------	-------	--------	---------	--------------------	----

Diesel Common Rail Pump

1.5 dCi (JM16)	76 kW	01/07→	K9K 734	A2C59511605	15
----------------	-------	--------	---------	--------------------	----

RENAULT - SCÉNIC III (JZ0/1_) 12/08→

Common Rail Diesel Injector

1.5 dCi	78 kW	02/09→	K9K 832	A2C59513484	17
1.5 dCi	81 kW	04/09→	K9K 636	A2C59507596	11
			K9K 836 / K9K 837	A2C59513484	17
1.5 dCi (JZ02, JZ0R)	70 kW	11/10→	K9K 846	A2C59513484	17

Diesel Common Rail Pump

1.5 dCi	78 kW	02/09→	K9K 832	A2C59513595	18
1.5 dCi	81 kW	04/09→	K9K 636	A2C59507608	11
			K9K 836 / K9K 837	A2C59513595	18
1.5 dCi (JZ02, JZ0R)	70 kW	11/10→	K9K 846	A2C59513595	18

SEAT - ALTEA (5P1) 03/04→

Common Rail Diesel Injector

1.6 TDI	66 kW	11/10→	CAYB	A2C9626040080	22
1.6 TDI	77 kW	10/09→	CAYC	A2C9626040080	22

Diesel Common Rail Pump

1.6 TDI	66 kW	11/10→	CAYB	A2C59517047	20
1.6 TDI	77 kW	10/09→	CAYC	A2C59517047	20



VDO

**SEAT - ALTEA XL (5P5, 5P8) 10/06→****Common Rail Diesel Injector**

1.6 TDI	66 kW	11/10→	CAYB	A2C9626040080	22
1.6 TDI	77 kW	10/09→	CAYC	A2C9626040080	22

**Diesel Common Rail Pump**

1.6 TDI	66 kW	11/10→	CAYB	A2C59517047	20
1.6 TDI	77 kW	10/09→	CAYC	A2C59517047	20

SEAT - IBIZA IV (6J5, 6P1) 03/08→**Common Rail Diesel Injector**

1.6 TDI	55 kW	05/09→	CAYA	A2C9626040080	22
1.6 TDI	66 kW	05/09→	CAYB; PR: XXXXXXXX → 6J-9-000001	A2C9626040080	22
1.6 TDI	77 kW	05/09→	CLNA / CAYC; PR: XXXXXXXX → 6J-9-000001	A2C9626040080	22

**Diesel Common Rail Pump**

1.6 TDI	66 kW	05/09→	CAYB; PR: XXXXXXXX → 6J-9-000001	A2C59517047	20
1.6 TDI	77 kW	05/09→	CAYC; PR: XXXXXXXX → 6J-9-000001	A2C59517047	20

SEAT - IBIZA IV SPORTCOUPE (6J1, 6P5) 07/08→**Common Rail Diesel Injector**

1.6 TDI	55 kW	05/10→06/10	CAYA	A2C9626040080	22
1.6 TDI	66 kW	05/09→	CAYB; PR: XXXXXXXX → 6J-9-000001	A2C9626040080	22
1.6 TDI	77 kW	05/09→	CLNA / CAYC; PR: XXXXXXXX → 6J-9-000001	A2C9626040080	22

**Diesel Common Rail Pump**

1.6 TDI	66 kW	05/09→	CAYB; PR: XXXXXXXX → 6J-9-000001	A2C59517047	20
1.6 TDI	77 kW	05/09→	CAYC; PR: XXXXXXXX → 6J-9-000001	A2C59517047	20

SEAT - IBIZA IV ST (6J8, 6P8) 03/10→**Common Rail Diesel Injector**

1.6 TDI	66 kW	03/10→	CAYB; PR: XXXXXXXX → 6J-9-000001	A2C9626040080	22
1.6 TDI	77 kW	03/10→	CLNA / CAYC; PR: XXXXXXXX → 6J-9-000001	A2C9626040080	22

**Diesel Common Rail Pump**

1.6 TDI	66 kW	03/10→	CAYB; PR: XXXXXXXX → 6J-9-000001	A2C59517047	20
1.6 TDI	77 kW	03/10→	CAYC; PR: XXXXXXXX → 6J-9-000001	A2C59517047	20

SEAT - LEON (1P1) 05/05→12/13**Common Rail Diesel Injector**

1.6 TDI	66 kW	11/10→12/12	CAYB	A2C9626040080	22
1.6 TDI	77 kW	02/10→12/12	CAYC	A2C9626040080	22

**Diesel Common Rail Pump**

1.6 TDI	66 kW	11/10→12/12	CAYB	A2C59517047	20
1.6 TDI	77 kW	02/10→12/12	CAYC; PR: XXXXXXXX → 1P-6-000 001	A2C59517047	20

SEAT - TOLEDO IV (KG3) 07/12→**Common Rail Diesel Injector**

1.6 TDI	77 kW	07/12→	CAYC / CLNA	A2C9626040080	22
---------	-------	--------	--------------	----------------------	----

**Diesel Common Rail Pump**

1.6 TDI	66 kW	06/13→	CAYB; for PR number (C11): 7MJ	A2C59517047	20
1.6 TDI	77 kW	07/12→	CAYC / CLNA; for PR number (C11): 7MJ	A2C59517047	20

SKODA - FABIA II (542) 12/06→12/14**Common Rail Diesel Injector**

1.6 TDI	55 kW	04/10→12/14	CAYA	A2C9626040080	22
1.6 TDI	66 kW	03/10→12/14	CAYB; Model year from (C20): 2011	A2C9626040080	22
1.6 TDI	77 kW	03/10→12/14	CAYC; Model year from (C20): 2011	A2C9626040080	22



VDO

SKODA - FABIA II (542) 12/06→12/14

Diesel Common Rail Pump

1.6 TDI	55 kW	04/10→12/14	CAYA	A2C59517047	20
1.6 TDI	66 kW	03/10→12/14	CAYB	A2C59517047	20
1.6 TDI	77 kW	03/10→12/14	CAYC	A2C59517047	20

SKODA - FABIA II Combi (545) 10/07→12/14

Common Rail Diesel Injector

1.6 TDI	55 kW	04/10→12/14	CAYA	A2C9626040080	22
1.6 TDI	66 kW	03/10→12/14	CAYB; Model year from (C20): 2011	A2C9626040080	22
1.6 TDI	77 kW	03/10→12/14	CAYC; Model year from (C20): 2011	A2C9626040080	22

Diesel Common Rail Pump

1.6 TDI	55 kW	04/10→12/14	CAYA	A2C59517047	20
1.6 TDI	66 kW	03/10→12/14	CAYB	A2C59517047	20
1.6 TDI	77 kW	03/10→12/14	CAYC	A2C59517047	20

SKODA - OCTAVIA II (1Z3) 02/04→06/13

Common Rail Diesel Injector

1.6 TDI	77 kW	06/09→04/13	CAYC	A2C9626040080	22
---------	-------	-------------	------	----------------------	----

Diesel Common Rail Pump

1.6 TDI	77 kW	06/09→04/13	CAYC; → 1Z-9-000 001	A2C59517047	20
---------	-------	-------------	-----------------------	--------------------	----

SKODA - OCTAVIA II Combi (1Z5) 02/04→06/13

Common Rail Diesel Injector

1.6 TDI	77 kW	06/09→04/13	CAYC	A2C9626040080	22
---------	-------	-------------	------	----------------------	----

Diesel Common Rail Pump

1.6 TDI	77 kW	06/09→04/13	CAYC; → 1Z-9-000 001	A2C59517047	20
1.6 TDI 4x4	77 kW	06/09→02/13	CAYC; → 1Z-9-000001	A2C59517047	20

SKODA - RAPID (NH3) 07/12→

Common Rail Diesel Injector

1.6 TDI	66 kW	08/13→	CAYB	A2C9626040080	22
1.6 TDI	77 kW	07/12→	CLNA	A2C9626040080	22

Diesel Common Rail Pump

1.6 TDI	66 kW	08/13→	CAYB; for PR number (C11): 7MJ, 7MG	A2C59517047	20
1.6 TDI	77 kW	07/12→	CLNA / CAYC; for PR number (C11): 7MJ, 7MG	A2C59517047	20
			CLNA	A2C59517049	21

SKODA - RAPID Spaceback (NH1) 07/12→

Diesel Common Rail Pump

1.6 TDI	66 kW	08/13→	CAYB; for PR number (C11): 7MJ, 7MG	A2C59517047	20
1.6 TDI	77 kW	07/12→	CLNA / CAYC; for PR number (C11): 7MJ, 7MG	A2C59517047	20
			CLNA	A2C59517049	21

SKODA - ROOMSTER (5J) 03/06→05/15

Common Rail Diesel Injector

1.6 TDI	66 kW	03/10→05/15	CAYB	A2C9626040080	22
1.6 TDI	77 kW	03/10→05/15	CAYC	A2C9626040080	22

Diesel Common Rail Pump

1.6 TDI	66 kW	03/10→05/15	CAYB	A2C59517047	20
1.6 TDI	77 kW	03/10→05/15	CAYC	A2C59517047	20

SKODA - ROOMSTER Praktik (5J) 03/07→05/15

Common Rail Diesel Injector

1.6 TDI	66 kW	03/10→05/15	CAYB	A2C9626040080	22
---------	-------	-------------	------	----------------------	----



					VDO	
SKODA - ROOMSTER Praktik (5J) 03/07→05/15						
Diesel Common Rail Pump						
1.6 TDI	66 kW	03/10→05/15		CAYB	A2C59517047	20
SKODA - SUPERB II (3T4) 03/08→05/15						
Common Rail Diesel Injector						
1.6 TDI	77 kW	09/10→05/15		CAYC; → 3T-8-000001	A2C9626040080	22
Diesel Common Rail Pump						
1.6 TDI	77 kW	09/10→05/15		CAYC; → 3T-8-000 001	A2C59517047	20
SKODA - SUPERB II Estate (3T5) 10/09→05/15						
Common Rail Diesel Injector						
1.6 TDI	77 kW	09/10→05/15		CAYC; → 3T-8-000001	A2C9626040080	22
Diesel Common Rail Pump						
1.6 TDI	77 kW	09/10→05/15		CAYC; → 3T-8-000 001	A2C59517047	20
SKODA - YETI (5L) 05/09→12/17						
Common Rail Diesel Injector						
1.6 TDI	77 kW	11/10→05/15		CAYC	A2C9626040080	22
Diesel Common Rail Pump						
1.6 TDI	77 kW	11/10→05/15		CAYC	A2C59517047	20
TOYOTA - AIGO (_B1_) 02/05→05/14						
Common Rail Diesel Injector						
1.4 HDi (WNB10_)	40 kW	07/05→08/10		2WZ-TV	A2C59511612	16
VOLVO - C30 (533) 09/06→12/13						
Common Rail Diesel Injector						
1.6 D2	84 kW	10/10→12/12		D 4162 T	A2C59513556	18
2.0 D	100 kW	10/06→12/12		D 4204 T; Version (C2): Class 4	5WS40156-4Z	9
				D 4204 T; Version (C2): Class 5	5WS40156-Z	9
Diesel Common Rail Pump						
1.6 D2	84 kW	10/10→12/12		D 4162 T	A2C59513829	19
2.0 D	100 kW	10/06→12/12		D 4204 T	A2C59511600	13
VOLVO - C70 II Convertible (542) 03/06→12/13						
Common Rail Diesel Injector						
2.0 D	100 kW	01/08→10/09		D 4204 T; Version (C2): Class 4	5WS40156-4Z	9
				D 4204 T; Version (C2): Class 5	5WS40156-Z	9
Diesel Common Rail Pump						
2.0 D	100 kW	01/08→10/09		D 4204 T	A2C59511600	13
VOLVO - S40 II (544) 12/03→12/12						
Common Rail Diesel Injector						
1.6 D2	84 kW	10/10→12/12		D 4162 T	A2C59513556	18
2.0 D	100 kW	01/04→12/10		D 4204 T; Version (C2): Class 4	5WS40156-4Z	9
				D 4204 T; Version (C2): Class 5	5WS40156-Z	9
Diesel Common Rail Pump						
1.6 D2	84 kW	10/10→12/12		D 4162 T	A2C59513829	19
2.0 D	100 kW	01/04→12/10		D 4204 T	A2C59511600	13
VOLVO - S60 II (134) 04/10→						
Common Rail Diesel Injector						
DRIVE / D2	84 kW	01/11→12/15		D 4162 T	A2C59513556	18



VDO

VOLVO - S60 II (134) 04/10→
Diesel Common Rail Pump

DRIVE / D2	84 kW	01/11→12/15	D 4162 T	A2C59513829	19
------------	-------	-------------	----------	--------------------	----

VOLVO - S80 II (124) 03/06→
Common Rail Diesel Injector

1.6 DRIVE	84 kW	06/11→	D 4162 T	A2C59513556	18
-----------	-------	--------	----------	--------------------	----

2.0 TDi	100 kW	02/08→03/11	D 4204 T; Version (C2): Class 4	5WS40156-4Z	9
---------	--------	-------------	---------------------------------	--------------------	---

			D 4204 T; Version (C2): Class 5	5WS40156-Z	9
--	--	--	---------------------------------	-------------------	---

Diesel Common Rail Pump

1.6 DRIVE	84 kW	06/11→	D 4162 T	A2C59513829	19
-----------	-------	--------	----------	--------------------	----

2.0 TDi	100 kW	02/08→03/11	D 4204 T	A2C59511600	13
---------	--------	-------------	----------	--------------------	----

VOLVO - V40 Hatchback (525, 526) 03/12→
Common Rail Diesel Injector

D2	84 kW	03/12→	D 4162 T	A2C59513556	18
----	-------	--------	----------	--------------------	----

Diesel Common Rail Pump

D2	84 kW	03/12→	D 4162 T	A2C59513829	19
----	-------	--------	----------	--------------------	----

VOLVO - V50 (545) 12/03→12/12
Common Rail Diesel Injector

1.6 D2	84 kW	01/10→12/12	D 4162 T	A2C59513556	18
--------	-------	-------------	----------	--------------------	----

2.0 D	100 kW	04/04→12/10	D 4204 T; Version (C2): Class 4	5WS40156-4Z	9
-------	--------	-------------	---------------------------------	--------------------	---

			D 4204 T; Version (C2): Class 5	5WS40156-Z	9
--	--	--	---------------------------------	-------------------	---

Diesel Common Rail Pump

1.6 D2	84 kW	01/10→12/12	D 4162 T	A2C59513829	19
--------	-------	-------------	----------	--------------------	----

2.0 D	100 kW	04/04→12/10	D 4204 T	A2C59511600	13
-------	--------	-------------	----------	--------------------	----

VOLVO - V60 (155, 157) 07/10→
Common Rail Diesel Injector

1.6 DRIVE	84 kW	02/11→12/15	D 4162 T	A2C59513556	18
-----------	-------	-------------	----------	--------------------	----

Diesel Common Rail Pump

1.6 DRIVE	84 kW	02/11→12/15	D 4162 T	A2C59513829	19
-----------	-------	-------------	----------	--------------------	----

VOLVO - V70 III (135) 04/07→
Common Rail Diesel Injector

1.6 DRIVE / D2	84 kW	04/11→12/15	D 4162 T	A2C59513556	18
----------------	-------	-------------	----------	--------------------	----

2.0 D	100 kW	10/07→12/15	D 4204 T; Version (C2): Class 4	5WS40156-4Z	9
-------	--------	-------------	---------------------------------	--------------------	---

			D 4204 T; Version (C2): Class 5	5WS40156-Z	9
--	--	--	---------------------------------	-------------------	---

Diesel Common Rail Pump

1.6 DRIVE / D2	84 kW	04/11→12/15	D 4162 T	A2C59513829	19
----------------	-------	-------------	----------	--------------------	----

2.0 D	100 kW	10/07→12/15	D 4204 T	A2C59511600	13
-------	--------	-------------	----------	--------------------	----

VW - BEETLE (5C1, 5C2) 04/11→
Common Rail Diesel Injector

1.6 TDI	77 kW	10/11→07/16	CAYC	A2C9626040080	22
---------	-------	-------------	------	----------------------	----

Diesel Common Rail Pump

1.6 TDI	77 kW	10/11→07/16		A2C59517047	20
---------	-------	-------------	--	--------------------	----

VW - BEETLE Convertible (5C7, 5C8) 12/11→
Common Rail Diesel Injector

1.6 TDI	77 kW	12/11→07/16	CAYC	A2C9626040080	22
---------	-------	-------------	------	----------------------	----



VDO

**VW - BEETLE Convertible (5C7, 5C8) 12/11→**

	Diesel Common Rail Pump					
1.6 TDI	77 kW	12/11→07/16		CAYC	A2C59517047	20

VW - CADDY III Box (2KA, 2KH, 2CA, 2CH) 03/04→05/15

	Common Rail Diesel Injector					
1.6 TDI	55 kW	08/10→05/15		CAYE; → 2K-B-200001	A2C9626040080	22
1.6 TDI	75 kW	08/10→05/15		CAYD; → 2K-B-200001	A2C9626040080	22

	Diesel Common Rail Pump					
1.6 TDI	55 kW	08/10→05/15		CAYE; → 2K-B-200 001 ; for PR number (C11): 7MG, 7MQ, 7MJ	A2C59517047	20
1.6 TDI	75 kW	08/10→05/15		CAYD; → 2K-B-200 001 ; for PR number (C11): 7MG, 7MQ, 7MJ	A2C59517047	20

VW - CADDY III Estate (2KB, 2KJ, 2CB, 2CJ) 03/04→05/15

	Common Rail Diesel Injector					
1.6 TDI	55 kW	08/10→05/15		CAYE; → 2K-B-200001	A2C9626040080	22
1.6 TDI	75 kW	08/10→05/15		CAYD; → 2K-B-200001	A2C9626040080	22

	Diesel Common Rail Pump					
1.6 TDI	55 kW	08/10→05/15		CAYE; → 2K-B-200 001 ; for PR number (C11): 7MG, 7MQ, 7MJ	A2C59517047	20
1.6 TDI	75 kW	08/10→05/15		CAYD; → 2K-B-200 001 ; for PR number (C11): 7MG, 7MQ, 7MJ	A2C59517047	20

VW - CADDY IV Box (SAA, SAH) 05/15→

	Common Rail Diesel Injector					
1.6 TDI	55 kW	05/15→11/17		CAYE	A2C9626040080	22
1.6 TDI	75 kW	05/15→		CAYD	A2C9626040080	22

	Diesel Common Rail Pump					
1.6 TDI	55 kW	05/15→11/17		CAYE; → 2K-B-200 001 ; for PR number (C11): 7MG, 7MQ, 7MJ / TF3	A2C59517047	20
1.6 TDI	75 kW	05/15→		CAYD; → 2K-B-200 001 ; for PR number (C11): 7MG, 7MQ, 7MJ / TF3	A2C59517047	20

VW - CADDY IV Estate (SAB, SAJ) 05/15→

	Common Rail Diesel Injector					
1.6 TDI	55 kW	05/15→11/17		CAYE	A2C9626040080	22
1.6 TDI	75 kW	05/15→		CAYD	A2C9626040080	22

	Diesel Common Rail Pump					
1.6 TDI	55 kW	05/15→11/17		CAYE; → 2K-B-200 001 ; for PR number (C11): 7MG, 7MQ, 7MJ / TF3	A2C59517047	20
1.6 TDI	75 kW	05/15→		CAYD; → 2K-B-200 001 ; for PR number (C11): 7MG, 7MQ, 7MJ / TF3	A2C59517047	20

VW - GOLF VI (5K1) 10/08→11/13

	Common Rail Diesel Injector					
1.6 TDI	66 kW	02/09→11/12		CAYB	A2C9626040080	22
1.6 TDI	77 kW	02/09→11/12		CAYC	A2C9626040080	22

	Diesel Common Rail Pump					
1.6 TDI	66 kW	02/09→11/12		CAYB; → 1K-9-400 001	A2C59517047	20
1.6 TDI	77 kW	02/09→11/12		CAYC; → 1K-9-400 001	A2C59517047	20

VW - GOLF VI Convertible (517) 03/11→05/16

	Common Rail Diesel Injector					
1.6 TDI	77 kW	03/11→05/16		CAYC	A2C9626040080	22



VW - GOLF VI Convertible (517) 03/11→05/16	
Diesel Common Rail Pump	
1.6 TDI	77 kW 03/11→05/16 CAYC; for PR number (C11): TF3 A2C59517047 20
VW - GOLF VI Variant (AJ5) 07/09→07/13	
Common Rail Diesel Injector	
1.6 TDI	66 kW 12/09→07/13 CAYB A2C9626040080 22
1.6 TDI	77 kW 07/09→07/13 CAYC A2C9626040080 22
1.6 TDI 4motion	77 kW 07/09→07/13 CAYC; → 1K-9-400001 A2C9626040080 22
Diesel Common Rail Pump	
1.6 TDI	66 kW 12/09→07/13 CAYB; → 1K-9-400 001 A2C59517047 20
1.6 TDI	77 kW 07/09→07/13 CAYC; → 1K-9-400 001 A2C59517047 20
1.6 TDI 4motion	77 kW 07/09→07/13
VW - GOLF PLUS (5M1, 521) 12/04→12/13	
Common Rail Diesel Injector	
1.6 TDI	66 kW 02/09→12/13 CAYB; → 1K-9-900001 A2C9626040080 22
1.6 TDI	77 kW 03/09→12/13 CAYC; → 1K-9-900001 A2C9626040080 22
Diesel Common Rail Pump	
1.6 TDI	66 kW 02/09→12/13 CAYB; → 1K-9-900 001 A2C59517047 20
1.6 TDI	77 kW 03/09→12/13 CAYC; → 1K-9-900 001 A2C59517047 20
VW - JETTA III (1K2) 09/04→10/10	
Common Rail Diesel Injector	
1.6 TDI	66 kW 12/09→10/10 CAYB A2C9626040080 22
1.6 TDI	77 kW 06/09→10/10 CAYC A2C9626040080 22
Diesel Common Rail Pump	
1.6 TDI	66 kW 12/09→10/10 CAYB A2C59517047 20
1.6 TDI	77 kW 06/09→10/10 CAYC A2C59517047 20
VW - JETTA IV (162, 163, AV3, AV2) 09/09→	
Common Rail Diesel Injector	
1.6 TDI	77 kW 04/10→07/14 CAYC; → 16-B-000001 / 16-F-000001 A2C9626040080 22
Diesel Common Rail Pump	
1.6 TDI	77 kW 04/10→07/14 CAYC; → 16-B-000 001 / 16-F-000 001 A2C59517047 20
VW - PASSAT (3C2) 03/05→12/10	
Common Rail Diesel Injector	
1.6 TDI	77 kW 08/09→07/10 CAYC A2C9626040080 22
Diesel Common Rail Pump	
1.6 TDI	77 kW 08/09→07/10 CAYC A2C59517047 20
VW - PASSAT (362) 08/10→12/14	
Common Rail Diesel Injector	
1.6 TDI	77 kW 08/10→12/14 CAYC; → 3C-B-200001 A2C9626040080 22
Diesel Common Rail Pump	
1.6 TDI	77 kW 08/10→12/14 CAYC; → 3C-B-200001 A2C59517049 21
VW - PASSAT Variant (3C5) 08/05→11/11	
Common Rail Diesel Injector	
1.6 TDI	77 kW 08/09→11/10 CAYC A2C9626040080 22
Diesel Common Rail Pump	
1.6 TDI	77 kW 08/09→11/10 CAYC A2C59517047 20



					VDO	
VW - PASSAT Variant (365) 08/10→12/15						
Common Rail Diesel Injector						
1.6 TDI	77 kW	08/10→12/14	CAYC; → 3C-B-200001	A2C9626040080	22	
Diesel Common Rail Pump						
1.6 TDI	77 kW	08/10→12/14	CAYC; → 3C-B-200001	A2C59517049	21	
VW - POLO (6R1, 6C1) 03/09→						
Common Rail Diesel Injector						
1.6 TDI	55 kW	06/09→	CAYA; → 6R-A-000001	A2C9626040080	22	
1.6 TDI	66 kW	06/09→	CAYB; → 60-AT000001 / 6R-D-000001 / 6R-A-000001	A2C9626040080	22	
1.6 TDI	77 kW	06/09→	CLNA; → 6R-A-000001 / 60-AT000001 / 6R-D-000001 / 60-FT000001	A2C9626040080	22	
			CAYC; → 60-AT000001 / 6R-D-000001	A2C9626040080	22	
Diesel Common Rail Pump						
1.6 TDI	55 kW	06/09→	CAYA; → 6R-A-000 001 / 6R-D-000 001 / 6R-D-000001 ; for PR number (C11): 7MG, 7MQ	A2C59517047	20	
1.6 TDI	66 kW	06/09→	CAYB; → 6R-A-000 001 / 6R-D-000 001 ; for PR number (C11): 7MG, 7MQ	A2C59517047	20	
1.6 TDI	77 kW	06/09→	CAYC / CLNA; → 6R-A-000 001 / 6R-D-000 001 ; for PR number (C11): 7MG, 7MQ	A2C59517047	20	
			CLNA; → 60-AT000 001	A2C59517049	21	
VW - TOURAN (1T3) 05/10→05/15						
Common Rail Diesel Injector						
1.6 TDI	66 kW	05/10→05/15	CAYB; Model year from (C20): 2011	A2C9626040080	22	
1.6 TDI	77 kW	05/10→05/15	CAYC; Model year from (C20): 2011	A2C9626040080	22	
Diesel Common Rail Pump						
1.6 TDI	66 kW	05/10→05/15	CAYB	A2C59517047	20	
1.6 TDI	77 kW	05/10→05/15	CAYC	A2C59517047	20	



Cross-Reference List

Referenzliste

Liste de référence

Lista de referencia

Lista di referenze

Список Литературы



Article-No.	OE-No./Ref.-No.	Manufacturer	Product Name
2910000177400	BH1Q-9K546-AB	LAND ROVER	Common Rail Diesel Injector
2910000177400	A2C33349400	Continental After-market GmbH	Common Rail Diesel Injector
2910000177400	A2C53421318	Continental After-market GmbH	Common Rail Diesel Injector
2910000177400	LR032067	LAND ROVER	Common Rail Diesel Injector
5WS40000-Z	5WS40000	Continental After-market GmbH	Common Rail Diesel Injector
5WS40000-Z	9652173780	PEUGEOT	Common Rail Diesel Injector
5WS40000-Z	1980F0	PEUGEOT	Common Rail Diesel Injector
5WS40000-Z	00001980F0	PEUGEOT	Common Rail Diesel Injector
5WS40000-Z	9652173780	CITROËN	Common Rail Diesel Injector
5WS40000-Z	1980F0	CITROËN	Common Rail Diesel Injector
5WS40000-Z	00001980F0	CITROËN	Common Rail Diesel Injector
5WS40018-Z	00001920CG	CITROËN	Diesel Common Rail Pump
5WS40018-Z	9658195080	CITROËN	Diesel Common Rail Pump
5WS40018-Z	9658195080	PEUGEOT	Diesel Common Rail Pump
5WS40018-Z	5WS40018	Continental After-market GmbH	Diesel Common Rail Pump
5WS40018-Z	A2C20000502	Continental After-market GmbH	Diesel Common Rail Pump
5WS40018-Z	1920CG	PEUGEOT	Diesel Common Rail Pump
5WS40018-Z	00001920CG	PEUGEOT	Diesel Common Rail Pump
5WS40018-Z	1920CG	CITROËN	Diesel Common Rail Pump
5WS40148-Z	00001980E7	CITROËN	Common Rail Diesel Injector
5WS40148-Z	9655304780	CITROËN	Common Rail Diesel Injector
5WS40148-Z	5WS40148	Continental After-market GmbH	Common Rail Diesel Injector
5WS40148-Z	5WS40007	Continental After-market GmbH	Common Rail Diesel Injector
5WS40148-Z	9655304880	PEUGEOT	Common Rail Diesel Injector
5WS40148-Z	9655304780	PEUGEOT	Common Rail Diesel Injector
5WS40148-Z	1980E7	PEUGEOT	Common Rail Diesel Injector
5WS40148-Z	00001980E7	PEUGEOT	Common Rail Diesel Injector
5WS40148-Z	2S6Q9F593BB	FORD	Common Rail Diesel Injector
5WS40148-Z	2S6Q9F593AC	FORD	Common Rail Diesel Injector
5WS40148-Z	2S6Q9F593AB	FORD	Common Rail Diesel Injector
5WS40148-Z	2S6Q9F593AA	FORD	Common Rail Diesel Injector

Article-No.	OE-No./Ref.-No.	Manufacturer	Product Name
5WS40148-Z	9655304880	CITROËN	Common Rail Diesel Injector
5WS40156-4Z	00001980J4	CITROËN	Common Rail Diesel Injector
5WS40156-4Z	1980J4	CITROËN	Common Rail Diesel Injector
5WS40156-4Z	00001980J4	PEUGEOT	Common Rail Diesel Injector
5WS40156-4Z	1980J4	PEUGEOT	Common Rail Diesel Injector
5WS40156-4Z	5WS40156-4	Continental After-market GmbH	Common Rail Diesel Injector
5WS40156-4Z	36000317	VOLVO	Common Rail Diesel Injector
5WS40156-4Z	36000315	VOLVO	Common Rail Diesel Injector
5WS40156-4Z	3M5Q9F593DB	FORD	Common Rail Diesel Injector
5WS40156-4Z	1373549	FORD	Common Rail Diesel Injector
5WS40156-4Z	9657144680	FIAT	Common Rail Diesel Injector
5WS40156-Z	00001980J5	CITROËN	Common Rail Diesel Injector
5WS40156-Z	1980J5	CITROËN	Common Rail Diesel Injector
5WS40156-Z	1373550	FORD	Common Rail Diesel Injector
5WS40156-Z	3M5Q9F593EB	FORD	Common Rail Diesel Injector
5WS40156-Z	00001980J5	PEUGEOT	Common Rail Diesel Injector
5WS40156-Z	1980J5	PEUGEOT	Common Rail Diesel Injector
5WS40156-Z	36000318	VOLVO	Common Rail Diesel Injector
5WS40156-Z	36000319	VOLVO	Common Rail Diesel Injector
5WS40156-Z	5WS40156	Continental After-market GmbH	Common Rail Diesel Injector
5WS40809-Z	00001920QH	CITROËN	Diesel Common Rail Pump
5WS40809-Z	1920QH	CITROËN	Diesel Common Rail Pump
5WS40809-Z	9688153080	CITROËN	Diesel Common Rail Pump
5WS40809-Z	9681945580	FIAT	Diesel Common Rail Pump
5WS40809-Z	9684704880	FIAT	Diesel Common Rail Pump
5WS40809-Z	1373546	FORD	Diesel Common Rail Pump
5WS40809-Z	3M5Q9A543BD	FORD	Diesel Common Rail Pump
5WS40809-Z	00001920QH	PEUGEOT	Diesel Common Rail Pump
5WS40809-Z	1920QH	PEUGEOT	Diesel Common Rail Pump
5WS40809-Z	9688153080	PEUGEOT	Diesel Common Rail Pump
5WS40809-Z	5WS40809	Continental After-market GmbH	Diesel Common Rail Pump



Article-No.	OE-No./Ref.-No.	Manufacturer	Product Name
5WS40809-Z	A2C20000598	Continental After-market GmbH	Diesel Common Rail Pump
A2C1637670080	2011886	FORD	Diesel Common Rail Pump
A2C1637670080	GK2Q-9B395-AA	FORD	Diesel Common Rail Pump
A2C1637670080	GK2Q-9B395-AB	FORD	Diesel Common Rail Pump
A2C1637670080	GK2Q9B395AA	FORD	Diesel Common Rail Pump
A2C1637670080	GK2Q9B395AB	FORD	Diesel Common Rail Pump
A2C1637670080	A2C8716550080	VDO	Diesel Common Rail Pump
A2C1637670080	2215504	FORD	Diesel Common Rail Pump
A2C1637670080	HG9Q-9B395-AA	FORD	Diesel Common Rail Pump
A2C1637670080	HG9Q9B395AA	FORD	Diesel Common Rail Pump
A2C3999700080	7001105C1	NAVISTAR	Common Rail Diesel Injector
A2C5328876880	BK2Q9D280BB	FORD	Distributor Pipe, fuel
A2C5328876880	1717578	FORD	Distributor Pipe, fuel
A2C5328876880	BK2Q9D280AB	FORD	Distributor Pipe, fuel
A2C5328876880	U21313150	MAZDA	Distributor Pipe, fuel
A2C5328876880	A2C53288768	Continental After-market GmbH	Distributor Pipe, fuel
A2C5338472780	7001106C1	NAVISTAR	Diesel Common Rail Pump
A2C59507596	16 60 065 26R	DACIA	Common Rail Diesel Injector
A2C59507596	16 60 062 12R	DACIA	Common Rail Diesel Injector
A2C59507596	166000Q1W	RENAULT	Common Rail Diesel Injector
A2C59507596	166006212R	RENAULT	Common Rail Diesel Injector
A2C59507596	166006526R	RENAULT	Common Rail Diesel Injector
A2C59507596	8201041272	RENAULT	Common Rail Diesel Injector
A2C59507596	8201041272	DACIA	Common Rail Diesel Injector
A2C59507596	A2C53381618	Continental After-market GmbH	Common Rail Diesel Injector
A2C59507608	A 607 070 00 00	MERCEDES-BENZ	Diesel Common Rail Pump
A2C59507608	A 607 070 00 01	MERCEDES-BENZ	Diesel Common Rail Pump
A2C59507608	16 70 036 69R	RENAULT	Diesel Common Rail Pump
A2C59507608	16 70 085 57R	RENAULT	Diesel Common Rail Pump
A2C59507608	16 70 089 97R	RENAULT	Diesel Common Rail Pump
A2C59507608	16 70 036 69R	DACIA	Diesel Common Rail Pump

Article-No.	OE-No./Ref.-No.	Manufacturer	Product Name
A2C59507608	16 70 085 57R	DACIA	Diesel Common Rail Pump
A2C59507608	16 70 089 97R	DACIA	Diesel Common Rail Pump
A2C59507608	A2C53351931	Continental After-market GmbH	Diesel Common Rail Pump
A2C59511316	00001980H1	CITROËN	Common Rail Diesel Injector
A2C59511316	1980H1	PEUGEOT	Common Rail Diesel Injector
A2C59511316	02C2S40004	JAGUAR	Common Rail Diesel Injector
A2C59511317	4R8Q9C066AA	FORD	Distributor Pipe, fuel
A2C59511318	1570G8	CITROËN	Distributor Pipe, fuel
A2C59511318	9653969680	CITROËN	Distributor Pipe, fuel
A2C59511318	1369551	FORD	Distributor Pipe, fuel
A2C59511318	4R8Q9D280AC	FORD	Distributor Pipe, fuel
A2C59511318	JDE2458	JAGUAR	Distributor Pipe, fuel
A2C59511318	JDE4062	JAGUAR	Distributor Pipe, fuel
A2C59511318	1570G8	PEUGEOT	Distributor Pipe, fuel
A2C59511318	9653969680	PEUGEOT	Distributor Pipe, fuel
A2C59511319	1369552	FORD	Distributor Pipe, fuel
A2C59511364	4H2Q9K546AF	FORD	Common Rail Diesel Injector
A2C59511364	LR006495	LAND ROVER	Common Rail Diesel Injector
A2C59511364	LR008836	LAND ROVER	Common Rail Diesel Injector
A2C59511600	1541974	FORD	Diesel Common Rail Pump
A2C59511600	3M5Q9A543CD	FORD	Diesel Common Rail Pump
A2C59511600	36002487	VOLVO	Diesel Common Rail Pump
A2C59511600	5WS40380	Continental After-market GmbH	Diesel Common Rail Pump
A2C59511600	A2C27100268	Continental After-market GmbH	Diesel Common Rail Pump
A2C59511601	00001980J6	CITROËN	Common Rail Diesel Injector
A2C59511601	1980J6	CITROËN	Common Rail Diesel Injector
A2C59511601	9657144880	FIAT	Common Rail Diesel Injector
A2C59511601	1483820	FORD	Common Rail Diesel Injector
A2C59511601	3M5Q9F593FB	FORD	Common Rail Diesel Injector
A2C59511601	00001980J6	PEUGEOT	Common Rail Diesel Injector
A2C59511601	1980J6	PEUGEOT	Common Rail Diesel Injector
A2C59511602	00001980K5	CITROËN	Common Rail Diesel Injector



Article-No.	OE-No./Ref.-No.	Manufacturer	Product Name
A2C59511602	1980K5	CITROËN	Common Rail Diesel Injector
A2C59511602	9659337980	FIAT	Common Rail Diesel Injector
A2C59511602	00001980K5	PEUGEOT	Common Rail Diesel Injector
A2C59511602	1980K5	PEUGEOT	Common Rail Diesel Injector
A2C59511603	1980K8	CITROËN	Common Rail Diesel Injector
A2C59511603	1980K8	PEUGEOT	Common Rail Diesel Injector
A2C59511603	9658194180	PEUGEOT	Common Rail Diesel Injector
A2C59511603	1980Z4	PEUGEOT	Common Rail Diesel Injector
A2C59511603	9658194180	CITROËN	Common Rail Diesel Injector
A2C59511603	1980Z4	CITROËN	Common Rail Diesel Injector
A2C59511605	5WS40153	Continental After-market GmbH	Diesel Common Rail Pump
A2C59511605	A2C20000754	Continental After-market GmbH	Diesel Common Rail Pump
A2C59511605	8200821184	RENAULT	Diesel Common Rail Pump
A2C59511605	8200663258	RENAULT	Diesel Common Rail Pump
A2C59511605	8200430599	RENAULT	Diesel Common Rail Pump
A2C59511605	167008859R	RENAULT	Diesel Common Rail Pump
A2C59511605	16700 00Q1L	NISSAN	Diesel Common Rail Pump
A2C59511605	16700 00Q1C	NISSAN	Diesel Common Rail Pump
A2C59511605	16700 00Q0N	NISSAN	Diesel Common Rail Pump
A2C59511606	16600 00Q0H	NISSAN	Common Rail Diesel Injector
A2C59511606	16600 00Q0P	NISSAN	Common Rail Diesel Injector
A2C59511606	16600 00Q1T	NISSAN	Common Rail Diesel Injector
A2C59511606	166009445R	RENAULT	Common Rail Diesel Injector
A2C59511606	8200380253	RENAULT	Common Rail Diesel Injector
A2C59511606	8200842205	RENAULT	Common Rail Diesel Injector
A2C59511609	1543842	FORD	Diesel Common Rail Pump
A2C59511609	5WS40094	Continental After-market GmbH	Diesel Common Rail Pump
A2C59511609	A2C20003032	Continental After-market GmbH	Diesel Common Rail Pump
A2C59511609	4M5Q-9B395-AF	FORD	Diesel Common Rail Pump
A2C59511609	4M5Q-9B395-AE	FORD	Diesel Common Rail Pump
A2C59511609	4M5Q-9B395-AD	FORD	Diesel Common Rail Pump

Article-No.	OE-No./Ref.-No.	Manufacturer	Product Name
A2C59511610	1355051	FORD	Common Rail Diesel Injector
A2C59511610	4M5Q9F593AD	FORD	Common Rail Diesel Injector
A2C59511611	1432322	FORD	Common Rail Diesel Injector
A2C59511611	7T1Q9F593AB	FORD	Common Rail Diesel Injector
A2C59511612	00001980L0	CITROËN	Common Rail Diesel Injector
A2C59511612	1980L0	CITROËN	Common Rail Diesel Injector
A2C59511612	00001980L0	PEUGEOT	Common Rail Diesel Injector
A2C59511612	1980L0	PEUGEOT	Common Rail Diesel Injector
A2C59511612	9663429280	PEUGEOT	Common Rail Diesel Injector
A2C59511612	5WS40516	Continental After-market GmbH	Common Rail Diesel Injector
A2C59511612	5WS40149-Z	VDO	Common Rail Diesel Injector
A2C59511612	Y404-13-250A	MAZDA	Common Rail Diesel Injector
A2C59513481	LR006735	LAND ROVER	Diesel Common Rail Pump
A2C59513481	LR009737	LAND ROVER	Diesel Common Rail Pump
A2C59513481	LR010136	LAND ROVER	Diesel Common Rail Pump
A2C59513481	LR010189	LAND ROVER	Diesel Common Rail Pump
A2C59513481	5WS40254	Continental After-market GmbH	Diesel Common Rail Pump
A2C59513481	A2C20003180	Continental After-market GmbH	Diesel Common Rail Pump
A2C59513481	6H4Q9B395BG	FORD	Diesel Common Rail Pump
A2C59513482	LR005549	LAND ROVER	Diesel Common Rail Pump
A2C59513482	A2C20003282	Continental After-market GmbH	Diesel Common Rail Pump
A2C59513482	5WS40273	Continental After-market GmbH	Diesel Common Rail Pump
A2C59513482	LR049606	LAND ROVER	Diesel Common Rail Pump
A2C59513482	LR017367	LAND ROVER	Diesel Common Rail Pump
A2C59513482	LR009666	LAND ROVER	Diesel Common Rail Pump
A2C59513482	LR008831	LAND ROVER	Diesel Common Rail Pump
A2C59513482	7H2Q9B395CH	LAND ROVER	Diesel Common Rail Pump
A2C59513484	16600 00Q1F	NISSAN	Common Rail Diesel Injector
A2C59513484	16 60 043 05R	RENAULT	Common Rail Diesel Injector
A2C59513484	16 60 080 52R	RENAULT	Common Rail Diesel Injector
A2C59513484	8200903034	RENAULT	Common Rail Diesel Injector



Article-No.	OE-No./Ref.-No.	Manufacturer	Product Name
A2C59513484	16 60 043 05R	DACIA	Common Rail Diesel Injector
A2C59513484	16 60 080 52R	DACIA	Common Rail Diesel Injector
A2C59513484	8200903034	DACIA	Common Rail Diesel Injector
A2C59513553	7H2Q9K546CB	FORD	Common Rail Diesel Injector
A2C59513553	LR006496	LAND ROVER	Common Rail Diesel Injector
A2C59513553	LR008837	LAND ROVER	Common Rail Diesel Injector
A2C59513556	00001980ER	CITROËN	Common Rail Diesel Injector
A2C59513556	00001980ET	CITROËN	Common Rail Diesel Injector
A2C59513556	00001980R9	CITROËN	Common Rail Diesel Injector
A2C59513556	00001980S0	CITROËN	Common Rail Diesel Injector
A2C59513556	1980ER	CITROËN	Common Rail Diesel Injector
A2C59513556	1980ET	CITROËN	Common Rail Diesel Injector
A2C59513556	1980R9	CITROËN	Common Rail Diesel Injector
A2C59513556	1980S0	CITROËN	Common Rail Diesel Injector
A2C59513556	9802448680	CITROËN	Common Rail Diesel Injector
A2C59513556	1791017	FORD	Common Rail Diesel Injector
A2C59513556	1812616	FORD	Common Rail Diesel Injector
A2C59513556	00001980ER	PEUGEOT	Common Rail Diesel Injector
A2C59513556	00001980ET	PEUGEOT	Common Rail Diesel Injector
A2C59513556	00001980R9	PEUGEOT	Common Rail Diesel Injector
A2C59513556	00001980S0	PEUGEOT	Common Rail Diesel Injector
A2C59513556	1980ER	PEUGEOT	Common Rail Diesel Injector
A2C59513556	1980ET	PEUGEOT	Common Rail Diesel Injector
A2C59513556	1980R9	PEUGEOT	Common Rail Diesel Injector
A2C59513556	1980S0	PEUGEOT	Common Rail Diesel Injector
A2C59513556	9802448680	PEUGEOT	Common Rail Diesel Injector
A2C59513556	36001726	VOLVO	Common Rail Diesel Injector
A2C59513556	36001727	VOLVO	Common Rail Diesel Injector
A2C59513556	36001728	VOLVO	Common Rail Diesel Injector
A2C59513556	36001729	VOLVO	Common Rail Diesel Injector
A2C59513595	16700 00Q1F	NISSAN	Diesel Common Rail Pump































Article-No.	OE-No./Ref.-No.	Manufacturer	Product Name
A2C59513595	16700 00Q1M	NISSAN	Diesel Common Rail Pump
A2C59513595	16 70 000 61R	RENAULT	Diesel Common Rail Pump
A2C59513595	16 70 009 38R	RENAULT	Diesel Common Rail Pump
A2C59513595	8200704200	RENAULT	Diesel Common Rail Pump
A2C59513595	16 70 000 61R	DACIA	Diesel Common Rail Pump
A2C59513595	16 70 009 38R	DACIA	Diesel Common Rail Pump
A2C59513595	8200704200	DACIA	Diesel Common Rail Pump
A2C59513595	5WS40565	Continental After-market GmbH	Diesel Common Rail Pump
A2C59513595	A2C53252602	Continental After-market GmbH	Diesel Common Rail Pump
A2C59513596	6H4Q9K546DB	LAND ROVER	Common Rail Diesel Injector
A2C59513596	LR0008832	LAND ROVER	Common Rail Diesel Injector
A2C59513596	LR0008834	LAND ROVER	Common Rail Diesel Injector
A2C59513596	LR002473	LAND ROVER	Common Rail Diesel Injector
A2C59513596	LR002475	LAND ROVER	Common Rail Diesel Injector
A2C59513597	6H4Q9K546EB	LAND ROVER	Common Rail Diesel Injector
A2C59513597	LR0008833	LAND ROVER	Common Rail Diesel Injector
A2C59513597	LR0008835	LAND ROVER	Common Rail Diesel Injector
A2C59513597	LR002474	LAND ROVER	Common Rail Diesel Injector
A2C59513597	LR002476	LAND ROVER	Common Rail Diesel Injector
A2C59513829	1720038	FORD	Diesel Common Rail Pump
A2C59513829	1804823	FORD	Diesel Common Rail Pump
A2C59513829	36001730	VOLVO	Diesel Common Rail Pump
A2C59513829	5WS40893	Continental After-market GmbH	Diesel Common Rail Pump
A2C59513829	A2C53384062	Continental After-market GmbH	Diesel Common Rail Pump
A2C59513830	00001920QX	CITROËN	Diesel Common Rail Pump
A2C59513830	00001920RY	CITROËN	Diesel Common Rail Pump
A2C59513830	1920QX	CITROËN	Diesel Common Rail Pump
A2C59513830	1920RY	CITROËN	Diesel Common Rail Pump
A2C59513830	00001920QX	PEUGEOT	Diesel Common Rail Pump
A2C59513830	00001920RY	PEUGEOT	Diesel Common Rail Pump
A2C59513830	1920QX	PEUGEOT	Diesel Common Rail Pump



Article-No.	OE-No./Ref.-No.	Manufacturer	Product Name
A2C59513830	1920RY	PEUGEOT	Diesel Common Rail Pump
A2C59513830	5WS40894	Continental After-market GmbH	Diesel Common Rail Pump
A2C59513830	A2C53381555	Continental After-market GmbH	Diesel Common Rail Pump
A2C59515264	LK2400684	FORD	Common Rail Diesel Injector
A2C59517043	1717702	FORD	Diesel Common Rail Pump
A2C59517043	1841728	FORD	Diesel Common Rail Pump
A2C59517043	1849878	FORD	Diesel Common Rail Pump
A2C59517043	1881206	FORD	Diesel Common Rail Pump
A2C59517043	2033609	FORD	Diesel Common Rail Pump
A2C59517043	BK3Q-9B395-AD	FORD	Diesel Common Rail Pump
A2C59517043	BK3Q-9B395-CA	FORD	Diesel Common Rail Pump
A2C59517043	BK3Q9B395AD	FORD	Diesel Common Rail Pump
A2C59517043	BK3Q9B395AE	FORD	Diesel Common Rail Pump
A2C59517043	FB3Q-9B395-BA	FORD	Diesel Common Rail Pump
A2C59517043	FB3Q-9B395-BC	FORD	Diesel Common Rail Pump
A2C59517043	FB3Q9B395BB	FORD	Diesel Common Rail Pump
A2C59517043	U20213350C	MAZDA	Diesel Common Rail Pump
A2C59517043	LR029969	LAND ROVER	Diesel Common Rail Pump
A2C59517043	LR052872	LAND ROVER	Diesel Common Rail Pump
A2C59517043	5WS40695	Continental After-market GmbH	Diesel Common Rail Pump
A2C59517043	A2C53344441	Continental After-market GmbH	Diesel Common Rail Pump
A2C59517045	9678171880	CITROËN	Diesel Common Rail Pump
A2C59517045	1731745	FORD	Diesel Common Rail Pump
A2C59517045	1841726	FORD	Diesel Common Rail Pump
A2C59517045	BK2Q-9B395-BD	FORD	Diesel Common Rail Pump
A2C59517045	9678171880	PEUGEOT	Diesel Common Rail Pump
A2C59517045	5WS40694	Continental After-market GmbH	Diesel Common Rail Pump
A2C59517045	A2C53344443	Continental After-market GmbH	Diesel Common Rail Pump
A2C59517047	5WS40836	Continental After-market GmbH	Diesel Common Rail Pump
A2C59517047	A2C53341464	Continental After-market GmbH	Diesel Common Rail Pump
A2C59517047	03L 130 755 E	VW	Diesel Common Rail Pump

Article-No.	OE-No./Ref.-No.	Manufacturer	Product Name
A2C59517047	03L 130 755 AL	VW	Diesel Common Rail Pump
A2C59517047	03L 130 755 E	SKODA	Diesel Common Rail Pump
A2C59517047	03L 130 755 AL	SKODA	Diesel Common Rail Pump
A2C59517047	03L 130 755 E	AUDI	Diesel Common Rail Pump
A2C59517047	03L 130 755 AL	AUDI	Diesel Common Rail Pump
A2C59517047	03L 130 755 E	SEAT	Diesel Common Rail Pump
A2C59517047	03L 130 755 AL	SEAT	Diesel Common Rail Pump
A2C59517049	03L 130 755 AN	AUDI	Diesel Common Rail Pump
A2C59517049	03L 130 755 AN	SEAT	Diesel Common Rail Pump
A2C59517049	03L 130 755 AN	SKODA	Diesel Common Rail Pump
A2C59517049	03L 130 755 AN	VW	Diesel Common Rail Pump
A2C59517049	5WS40891	Continental After-market GmbH	Diesel Common Rail Pump
A2C59517049	A2C53366731	Continental After-market GmbH	Diesel Common Rail Pump
A2C59517051	9801125480	CITROËN	Common Rail Diesel Injector
A2C59517051	1746967	FORD	Common Rail Diesel Injector
A2C59517051	1840747	FORD	Common Rail Diesel Injector
A2C59517051	BK2Q-9K546-AG	FORD	Common Rail Diesel Injector
A2C59517051	9801125480	PEUGEOT	Common Rail Diesel Injector
A2C8139490080	1819881	FORD	Common Rail Diesel Injector
A2C8139490080	CK4Q9K546AA	FORD	Common Rail Diesel Injector
A2C9321760080	1881202	FORD	Diesel Common Rail Pump
A2C9321760080	FB3Q9B395AB	FORD	Diesel Common Rail Pump
A2C9321760080	U203-13-350	MAZDA	Diesel Common Rail Pump
A2C9626040080	03L 130 277 S	AUDI	Common Rail Diesel Injector
A2C9626040080	03L 130 277 S	VW	Common Rail Diesel Injector
A2C9626040080	03L 130 277 S	SKODA	Common Rail Diesel Injector
A2C9626040080	03L 130 277 S	SEAT	Common Rail Diesel Injector



OE-No./Ref.-No.	Manufacturer	Article-No.	Product Name
00001920CG	CITROËN	5WS40018-Z	 Diesel Common Rail Pump
00001920CG	PEUGEOT	5WS40018-Z	 Diesel Common Rail Pump
00001920QH	CITROËN	5WS40809-Z	 Diesel Common Rail Pump
00001920QH	PEUGEOT	5WS40809-Z	 Diesel Common Rail Pump
00001920QX	CITROËN	A2C59513830	 Diesel Common Rail Pump
00001920QX	PEUGEOT	A2C59513830	 Diesel Common Rail Pump
00001920RY	CITROËN	A2C59513830	 Diesel Common Rail Pump
00001920RY	PEUGEOT	A2C59513830	 Diesel Common Rail Pump
00001980E7	CITROËN	5WS40148-Z	 Common Rail Diesel Injector
00001980E7	PEUGEOT	5WS40148-Z	 Common Rail Diesel Injector
00001980ER	CITROËN	A2C59513556	 Common Rail Diesel Injector
00001980ER	PEUGEOT	A2C59513556	 Common Rail Diesel Injector
00001980ET	CITROËN	A2C59513556	 Common Rail Diesel Injector
00001980ET	PEUGEOT	A2C59513556	 Common Rail Diesel Injector
00001980F0	PEUGEOT	5WS40000-Z	 Common Rail Diesel Injector
00001980F0	CITROËN	5WS40000-Z	 Common Rail Diesel Injector
00001980H1	CITROËN	A2C59511316	 Common Rail Diesel Injector
00001980J4	CITROËN	5WS40156-4Z	 Common Rail Diesel Injector
00001980J4	PEUGEOT	5WS40156-4Z	 Common Rail Diesel Injector
00001980J5	CITROËN	5WS40156-Z	 Common Rail Diesel Injector
00001980J5	PEUGEOT	5WS40156-Z	 Common Rail Diesel Injector
00001980J6	CITROËN	A2C59511601	 Common Rail Diesel Injector
00001980J6	PEUGEOT	A2C59511601	 Common Rail Diesel Injector
00001980K5	CITROËN	A2C59511602	 Common Rail Diesel Injector
00001980K5	PEUGEOT	A2C59511602	 Common Rail Diesel Injector
00001980L0	CITROËN	A2C59511612	 Common Rail Diesel Injector
00001980L0	PEUGEOT	A2C59511612	 Common Rail Diesel Injector
00001980R9	CITROËN	A2C59513556	 Common Rail Diesel Injector
00001980R9	PEUGEOT	A2C59513556	 Common Rail Diesel Injector
00001980S0	CITROËN	A2C59513556	 Common Rail Diesel Injector
00001980S0	PEUGEOT	A2C59513556	Common Rail Diesel Injector

OE-No./Ref.-No.	Manufacturer	Article-No.	Product Name
02C2S40004	JAGUAR	A2C59511316	 Common Rail Diesel Injector
03L 130 277 S	AUDI	A2C9626040080	 Common Rail Diesel Injector
03L 130 277 S	VW	A2C9626040080	 Common Rail Diesel Injector
03L 130 277 S	SKODA	A2C9626040080	 Common Rail Diesel Injector
03L 130 277 S	SEAT	A2C9626040080	 Common Rail Diesel Injector
03L 130 755 AL	VW	A2C59517047	 Diesel Common Rail Pump
03L 130 755 AL	SKODA	A2C59517047	 Diesel Common Rail Pump
03L 130 755 AL	AUDI	A2C59517047	 Diesel Common Rail Pump
03L 130 755 AL	SEAT	A2C59517047	 Diesel Common Rail Pump
03L 130 755 AN	AUDI	A2C59517049	 Diesel Common Rail Pump
03L 130 755 AN	SEAT	A2C59517049	 Diesel Common Rail Pump
03L 130 755 AN	SKODA	A2C59517049	 Diesel Common Rail Pump
03L 130 755 AN	VW	A2C59517049	 Diesel Common Rail Pump
03L 130 755 E	VW	A2C59517047	 Diesel Common Rail Pump
03L 130 755 E	SKODA	A2C59517047	 Diesel Common Rail Pump
03L 130 755 E	AUDI	A2C59517047	 Diesel Common Rail Pump
03L 130 755 E	SEAT	A2C59517047	 Diesel Common Rail Pump
1355051	FORD	A2C59511610	 Common Rail Diesel Injector
1369551	FORD	A2C59511318	Distributor Pipe, fuel
1369552	FORD	A2C59511319	Distributor Pipe, fuel
1373546	FORD	5WS40809-Z	 Diesel Common Rail Pump
1373549	FORD	5WS40156-4Z	 Common Rail Diesel Injector
1373550	FORD	5WS40156-Z	 Common Rail Diesel Injector
1432322	FORD	A2C59511611	 Common Rail Diesel Injector
1483820	FORD	A2C59511601	 Common Rail Diesel Injector
1541974	FORD	A2C59511600	 Diesel Common Rail Pump
1543842	FORD	A2C59511609	 Diesel Common Rail Pump
1570G8	CITROËN	A2C59511318	Distributor Pipe, fuel
1570G8	PEUGEOT	A2C59511318	Distributor Pipe, fuel
16600 00Q0H	NISSAN	A2C59511606	 Common Rail Diesel Injector
16600 00Q0P	NISSAN	A2C59511606	 Common Rail Diesel Injector



Cross Reference List OE No. → Art.-No.

OE-No./Ref.-No.	Manufacturer	Article-No.	Product Name
16600 00Q1F	NISSAN	A2C59513484	Common Rail Diesel Injector
16600 00Q1T	NISSAN	A2C59511606	Common Rail Diesel Injector
1660000Q1W	RENAULT	A2C59507596	Common Rail Diesel Injector
16 60 043 05R	RENAULT	A2C59513484	Common Rail Diesel Injector
16 60 043 05R	DACIA	A2C59513484	Common Rail Diesel Injector
166006212R	RENAULT	A2C59507596	Common Rail Diesel Injector
16 60 062 12R	DACIA	A2C59507596	Common Rail Diesel Injector
166006526R	RENAULT	A2C59507596	Common Rail Diesel Injector
16 60 065 26R	DACIA	A2C59507596	Common Rail Diesel Injector
16 60 080 52R	RENAULT	A2C59513484	Common Rail Diesel Injector
16 60 080 52R	DACIA	A2C59513484	Common Rail Diesel Injector
166009445R	RENAULT	A2C59511606	Common Rail Diesel Injector
16 70 000 61R	RENAULT	A2C59513595	Diesel Common Rail Pump
16 70 000 61R	DACIA	A2C59513595	Diesel Common Rail Pump
16700 00Q0N	NISSAN	A2C59511605	Diesel Common Rail Pump
16700 00Q1C	NISSAN	A2C59511605	Diesel Common Rail Pump
16700 00Q1F	NISSAN	A2C59513595	Diesel Common Rail Pump
16700 00Q1L	NISSAN	A2C59511605	Diesel Common Rail Pump
16700 00Q1M	NISSAN	A2C59513595	Diesel Common Rail Pump
16 70 009 38R	RENAULT	A2C59513595	Diesel Common Rail Pump
16 70 009 38R	DACIA	A2C59513595	Diesel Common Rail Pump
16 70 036 69R	RENAULT	A2C59507608	Diesel Common Rail Pump
16 70 036 69R	DACIA	A2C59507608	Diesel Common Rail Pump
16 70 085 57R	RENAULT	A2C59507608	Diesel Common Rail Pump
16 70 085 57R	DACIA	A2C59507608	Diesel Common Rail Pump
167008859R	RENAULT	A2C59511605	Diesel Common Rail Pump
16 70 089 97R	RENAULT	A2C59507608	Diesel Common Rail Pump
16 70 089 97R	DACIA	A2C59507608	Diesel Common Rail Pump
1717578	FORD	A2C5328876880	Distributor Pipe, fuel
1717702	FORD	A2C59517043	Diesel Common Rail Pump
1720038	FORD	A2C59513829	Diesel Common Rail Pump

OE-No./Ref.-No.	Manufacturer	Article-No.	Product Name
1731745	FORD	A2C59517045	Diesel Common Rail Pump
1746967	FORD	A2C59517051	Common Rail Diesel Injector
1791017	FORD	A2C59513556	Common Rail Diesel Injector
1804823	FORD	A2C59513829	Diesel Common Rail Pump
1812616	FORD	A2C59513556	Common Rail Diesel Injector
1819881	FORD	A2C8139490080	Common Rail Diesel Injector
1840747	FORD	A2C59517051	Common Rail Diesel Injector
1841726	FORD	A2C59517045	Diesel Common Rail Pump
1841728	FORD	A2C59517043	Diesel Common Rail Pump
1849878	FORD	A2C59517043	Diesel Common Rail Pump
1881202	FORD	A2C9321760080	Diesel Common Rail Pump
1881206	FORD	A2C59517043	Diesel Common Rail Pump
1920CG	PEUGEOT	5WS40018-Z	Diesel Common Rail Pump
1920CG	CITROËN	5WS40018-Z	Diesel Common Rail Pump
1920QH	CITROËN	5WS40809-Z	Diesel Common Rail Pump
1920QH	PEUGEOT	5WS40809-Z	Diesel Common Rail Pump
1920QX	CITROËN	A2C59513830	Diesel Common Rail Pump
1920QX	PEUGEOT	A2C59513830	Diesel Common Rail Pump
1920RY	CITROËN	A2C59513830	Diesel Common Rail Pump
1920RY	PEUGEOT	A2C59513830	Diesel Common Rail Pump
1980E7	PEUGEOT	5WS40148-Z	Common Rail Diesel Injector
1980ER	CITROËN	A2C59513556	Common Rail Diesel Injector
1980ER	PEUGEOT	A2C59513556	Common Rail Diesel Injector
1980ET	CITROËN	A2C59513556	Common Rail Diesel Injector
1980ET	PEUGEOT	A2C59513556	Common Rail Diesel Injector
1980F0	PEUGEOT	5WS40000-Z	Common Rail Diesel Injector
1980F0	CITROËN	5WS40000-Z	Common Rail Diesel Injector
1980H1	PEUGEOT	A2C59511316	Common Rail Diesel Injector
1980J4	CITROËN	5WS40156-4Z	Common Rail Diesel Injector
1980J4	PEUGEOT	5WS40156-4Z	Common Rail Diesel Injector
1980J5	CITROËN	5WS40156-Z	Common Rail Diesel Injector



OE-No./Ref.-No.	Manufacturer	Article-No.	Product Name
1980J5	PEUGEOT	5WS40156-Z	Common Rail Diesel Injector
1980J6	CITROËN	A2C59511601	Common Rail Diesel Injector
1980J6	PEUGEOT	A2C59511601	Common Rail Diesel Injector
1980K5	CITROËN	A2C59511602	Common Rail Diesel Injector
1980K5	PEUGEOT	A2C59511602	Common Rail Diesel Injector
1980K8	CITROËN	A2C59511603	Common Rail Diesel Injector
1980K8	PEUGEOT	A2C59511603	Common Rail Diesel Injector
1980L0	CITROËN	A2C59511612	Common Rail Diesel Injector
1980L0	PEUGEOT	A2C59511612	Common Rail Diesel Injector
1980R9	CITROËN	A2C59513556	Common Rail Diesel Injector
1980R9	PEUGEOT	A2C59513556	Common Rail Diesel Injector
1980S0	CITROËN	A2C59513556	Common Rail Diesel Injector
1980S0	PEUGEOT	A2C59513556	Common Rail Diesel Injector
1980Z4	PEUGEOT	A2C59511603	Common Rail Diesel Injector
1980Z4	CITROËN	A2C59511603	Common Rail Diesel Injector
2011886	FORD	A2C1637670080	Diesel Common Rail Pump
2033609	FORD	A2C59517043	Diesel Common Rail Pump
2215504	FORD	A2C1637670080	Diesel Common Rail Pump
2S6Q9F593AA	FORD	5WS40148-Z	Common Rail Diesel Injector
2S6Q9F593AB	FORD	5WS40148-Z	Common Rail Diesel Injector
2S6Q9F593AC	FORD	5WS40148-Z	Common Rail Diesel Injector
2S6Q9F593BB	FORD	5WS40148-Z	Common Rail Diesel Injector
36000315	VOLVO	5WS40156-4Z	Common Rail Diesel Injector
36000317	VOLVO	5WS40156-4Z	Common Rail Diesel Injector
36000318	VOLVO	5WS40156-Z	Common Rail Diesel Injector
36000319	VOLVO	5WS40156-Z	Common Rail Diesel Injector
36001726	VOLVO	A2C59513556	Common Rail Diesel Injector
36001727	VOLVO	A2C59513556	Common Rail Diesel Injector
36001728	VOLVO	A2C59513556	Common Rail Diesel Injector
36001729	VOLVO	A2C59513556	Common Rail Diesel Injector
36001730	VOLVO	A2C59513829	Diesel Common Rail Pump

OE-No./Ref.-No.	Manufacturer	Article-No.	Product Name
36002487	VOLVO	A2C59511600	Diesel Common Rail Pump
3M5Q9A543BD	FORD	5WS40809-Z	Diesel Common Rail Pump
3M5Q9A543CD	FORD	A2C59511600	Diesel Common Rail Pump
3M5Q9F593DB	FORD	5WS40156-4Z	Common Rail Diesel Injector
3M5Q9F593EB	FORD	5WS40156-Z	Common Rail Diesel Injector
3M5Q9F593FB	FORD	A2C59511601	Common Rail Diesel Injector
4H2Q9K546AF	FORD	A2C59511364	Common Rail Diesel Injector
4M5Q-9B395-AD	FORD	A2C59511609	Diesel Common Rail Pump
4M5Q-9B395-AE	FORD	A2C59511609	Diesel Common Rail Pump
4M5Q-9B395-AF	FORD	A2C59511609	Diesel Common Rail Pump
4M5Q9F593AD	FORD	A2C59511610	Common Rail Diesel Injector
4R8Q9C066AA	FORD	A2C59511317	Distributor Pipe, fuel
4R8Q9D280AC	FORD	A2C59511318	Distributor Pipe, fuel
5WS40000	Continental After-market GmbH	5WS40000-Z	Common Rail Diesel Injector
5WS40007	Continental After-market GmbH	5WS40148-Z	Common Rail Diesel Injector
5WS40018	Continental After-market GmbH	5WS40018-Z	Diesel Common Rail Pump
5WS40094	Continental After-market GmbH	A2C59511609	Diesel Common Rail Pump
5WS40148	Continental After-market GmbH	5WS40148-Z	Common Rail Diesel Injector
5WS40149-Z	VDO	A2C59511612	Common Rail Diesel Injector
5WS40153	Continental After-market GmbH	A2C59511605	Diesel Common Rail Pump
5WS40156	Continental After-market GmbH	5WS40156-Z	Common Rail Diesel Injector
5WS40156-4	Continental After-market GmbH	5WS40156-4Z	Common Rail Diesel Injector
5WS40254	Continental After-market GmbH	A2C59513481	Diesel Common Rail Pump
5WS40273	Continental After-market GmbH	A2C59513482	Diesel Common Rail Pump
5WS40380	Continental After-market GmbH	A2C59511600	Diesel Common Rail Pump
5WS40516	Continental After-market GmbH	A2C59511612	Common Rail Diesel Injector
5WS40565	Continental After-market GmbH	A2C59513595	Diesel Common Rail Pump
5WS40694	Continental After-market GmbH	A2C59517045	Diesel Common Rail Pump
5WS40695	Continental After-market GmbH	A2C59517043	Diesel Common Rail Pump
5WS40809	Continental After-market GmbH	5WS40809-Z	Diesel Common Rail Pump
5WS40836	Continental After-market GmbH	A2C59517047	Diesel Common Rail Pump



Cross Reference List OE No. → Art.-No.

OE-No./Ref.-No.	Manufacturer	Article-No.	Product Name
5WS40891	Continental After-market GmbH	A2C59517049	Diesel Common Rail Pump
5WS40893	Continental After-market GmbH	A2C59513829	Diesel Common Rail Pump
5WS40894	Continental After-market GmbH	A2C59513830	Diesel Common Rail Pump
6H4Q9B395BG	FORD	A2C59513481	Diesel Common Rail Pump
6H4Q9K546DB	LAND ROVER	A2C59513596	Common Rail Diesel Injector
6H4Q9K546EB	LAND ROVER	A2C59513597	Common Rail Diesel Injector
7001105C1	NAVISTAR	A2C3999700080	Common Rail Diesel Injector
7001106C1	NAVISTAR	A2C5338472780	Diesel Common Rail Pump
7H2Q9B395CH	LAND ROVER	A2C59513482	Diesel Common Rail Pump
7H2Q9K546CB	FORD	A2C59513553	Common Rail Diesel Injector
7T1Q9F593AB	FORD	A2C59511611	Common Rail Diesel Injector
8200380253	RENAULT	A2C59511606	Common Rail Diesel Injector
8200430599	RENAULT	A2C59511605	Diesel Common Rail Pump
8200663258	RENAULT	A2C59511605	Diesel Common Rail Pump
8200704200	RENAULT	A2C59513595	Diesel Common Rail Pump
8200704200	DACIA	A2C59513595	Diesel Common Rail Pump
8200821184	RENAULT	A2C59511605	Diesel Common Rail Pump
8200842205	RENAULT	A2C59511606	Common Rail Diesel Injector
8200903034	RENAULT	A2C59513484	Common Rail Diesel Injector
8200903034	DACIA	A2C59513484	Common Rail Diesel Injector
8201041272	RENAULT	A2C59507596	Common Rail Diesel Injector
8201041272	DACIA	A2C59507596	Common Rail Diesel Injector
9652173780	PEUGEOT	5WS40000-Z	Common Rail Diesel Injector
9652173780	CITROËN	5WS40000-Z	Common Rail Diesel Injector
9653969680	CITROËN	A2C59511318	Distributor Pipe, fuel
9653969680	PEUGEOT	A2C59511318	Distributor Pipe, fuel
9655304780	CITROËN	5WS40148-Z	Common Rail Diesel Injector
9655304780	PEUGEOT	5WS40148-Z	Common Rail Diesel Injector
9655304880	PEUGEOT	5WS40148-Z	Common Rail Diesel Injector
9655304880	CITROËN	5WS40148-Z	Common Rail Diesel Injector
9657144680	FIAT	5WS40156-4Z	Common Rail Diesel Injector

OE-No./Ref.-No.	Manufacturer	Article-No.	Product Name
9657144880	FIAT	A2C59511601	Common Rail Diesel Injector
9658194180	PEUGEOT	A2C59511603	Common Rail Diesel Injector
9658194180	CITROËN	A2C59511603	Common Rail Diesel Injector
9658195080	CITROËN	5WS40018-Z	Diesel Common Rail Pump
9658195080	PEUGEOT	5WS40018-Z	Diesel Common Rail Pump
9659337980	FIAT	A2C59511602	Common Rail Diesel Injector
9663429280	PEUGEOT	A2C59511612	Common Rail Diesel Injector
9678171880	CITROËN	A2C59517045	Diesel Common Rail Pump
9678171880	PEUGEOT	A2C59517045	Diesel Common Rail Pump
9681945580	FIAT	5WS40809-Z	Diesel Common Rail Pump
9684704880	FIAT	5WS40809-Z	Diesel Common Rail Pump
9688153080	CITROËN	5WS40809-Z	Diesel Common Rail Pump
9688153080	PEUGEOT	5WS40809-Z	Diesel Common Rail Pump
9801125480	CITROËN	A2C59517051	Common Rail Diesel Injector
9801125480	PEUGEOT	A2C59517051	Common Rail Diesel Injector
9802448680	CITROËN	A2C59513556	Common Rail Diesel Injector
9802448680	PEUGEOT	A2C59513556	Common Rail Diesel Injector
A2C20000502	Continental After-market GmbH	5WS40018-Z	Diesel Common Rail Pump
A2C20000598	Continental After-market GmbH	5WS40809-Z	Diesel Common Rail Pump
A2C20000754	Continental After-market GmbH	A2C59511605	Diesel Common Rail Pump
A2C20003032	Continental After-market GmbH	A2C59511609	Diesel Common Rail Pump
A2C20003180	Continental After-market GmbH	A2C59513481	Diesel Common Rail Pump
A2C20003282	Continental After-market GmbH	A2C59513482	Diesel Common Rail Pump
A2C27100268	Continental After-market GmbH	A2C59511600	Diesel Common Rail Pump
A2C33349400	Continental After-market GmbH	2910000177400	Common Rail Diesel Injector
A2C53252602	Continental After-market GmbH	A2C59513595	Diesel Common Rail Pump
A2C53288768	Continental After-market GmbH	A2C5328876880	Distributor Pipe, fuel
A2C53341464	Continental After-market GmbH	A2C59517047	Diesel Common Rail Pump
A2C53344441	Continental After-market GmbH	A2C59517043	Diesel Common Rail Pump
A2C53344443	Continental After-market GmbH	A2C59517045	Diesel Common Rail Pump
A2C53351931	Continental After-market GmbH	A2C59507608	Diesel Common Rail Pump



OE-No./Ref.-No.	Manufacturer	Article-No.	Product Name
A2C53366731	Continental After-market GmbH	A2C59517049	Diesel Common Rail Pump
A2C53381555	Continental After-market GmbH	A2C59513830	Diesel Common Rail Pump
A2C53381618	Continental After-market GmbH	A2C59507596	Common Rail Diesel Injector
A2C53384062	Continental After-market GmbH	A2C59513829	Diesel Common Rail Pump
A2C53421318	Continental After-market GmbH	2910000177400	Common Rail Diesel Injector
A2C8716550080	VDO	A2C1637670080	Diesel Common Rail Pump
A 607 070 00 00	MERCEDES-BENZ	A2C59507608	Diesel Common Rail Pump
A 607 070 00 01	MERCEDES-BENZ	A2C59507608	Diesel Common Rail Pump
BH1Q-9K546-AB	LAND ROVER	2910000177400	Common Rail Diesel Injector
BK2Q-9B395-BD	FORD	A2C59517045	Diesel Common Rail Pump
BK2Q9D280AB	FORD	A2C5328876880	Distributor Pipe, fuel
BK2Q9D280BB	FORD	A2C5328876880	Distributor Pipe, fuel
BK2Q-9K546-AG	FORD	A2C59517051	Common Rail Diesel Injector
BK3Q9B395AD	FORD	A2C59517043	Diesel Common Rail Pump
BK3Q-9B395-AD	FORD	A2C59517043	Diesel Common Rail Pump
BK3Q9B395AE	FORD	A2C59517043	Diesel Common Rail Pump
BK3Q-9B395-CA	FORD	A2C59517043	Diesel Common Rail Pump
CK4Q9K546AA	FORD	A2C8139490080	Common Rail Diesel Injector
FB3Q9B395AB	FORD	A2C9321760080	Diesel Common Rail Pump
FB3Q-9B395-BA	FORD	A2C59517043	Diesel Common Rail Pump
FB3Q9B395BB	FORD	A2C59517043	Diesel Common Rail Pump
FB3Q-9B395-BC	FORD	A2C59517043	Diesel Common Rail Pump
GK2Q9B395AA	FORD	A2C1637670080	Diesel Common Rail Pump
GK2Q-9B395-AA	FORD	A2C1637670080	Diesel Common Rail Pump
GK2Q9B395AB	FORD	A2C1637670080	Diesel Common Rail Pump
GK2Q-9B395-AB	FORD	A2C1637670080	Diesel Common Rail Pump
HG9Q9B395AA	FORD	A2C1637670080	Diesel Common Rail Pump
HG9Q-9B395-AA	FORD	A2C1637670080	Diesel Common Rail Pump
JDE2458	JAGUAR	A2C59511318	Distributor Pipe, fuel
JDE4062	JAGUAR	A2C59511318	Distributor Pipe, fuel
LK2400684	FORD	A2C59515264	Common Rail Diesel Injector

OE-No./Ref.-No.	Manufacturer	Article-No.	Product Name
LR0008832	LAND ROVER	A2C59513596	Common Rail Diesel Injector
LR0008833	LAND ROVER	A2C59513597	Common Rail Diesel Injector
LR0008834	LAND ROVER	A2C59513596	Common Rail Diesel Injector
LR0008835	LAND ROVER	A2C59513597	Common Rail Diesel Injector
LR002473	LAND ROVER	A2C59513596	Common Rail Diesel Injector
LR002474	LAND ROVER	A2C59513597	Common Rail Diesel Injector
LR002475	LAND ROVER	A2C59513596	Common Rail Diesel Injector
LR002476	LAND ROVER	A2C59513597	Common Rail Diesel Injector
LR005549	LAND ROVER	A2C59513482	Diesel Common Rail Pump
LR006495	LAND ROVER	A2C59511364	Common Rail Diesel Injector
LR006496	LAND ROVER	A2C59513553	Common Rail Diesel Injector
LR006735	LAND ROVER	A2C59513481	Diesel Common Rail Pump
LR008831	LAND ROVER	A2C59513482	Diesel Common Rail Pump
LR008836	LAND ROVER	A2C59511364	Common Rail Diesel Injector
LR008837	LAND ROVER	A2C59513553	Common Rail Diesel Injector
LR009666	LAND ROVER	A2C59513482	Diesel Common Rail Pump
LR009737	LAND ROVER	A2C59513481	Diesel Common Rail Pump
LR010136	LAND ROVER	A2C59513481	Diesel Common Rail Pump
LR010189	LAND ROVER	A2C59513481	Diesel Common Rail Pump
LR017367	LAND ROVER	A2C59513482	Diesel Common Rail Pump
LR029969	LAND ROVER	A2C59517043	Diesel Common Rail Pump
LR032067	LAND ROVER	2910000177400	Common Rail Diesel Injector
LR049606	LAND ROVER	A2C59513482	Diesel Common Rail Pump
LR052872	LAND ROVER	A2C59517043	Diesel Common Rail Pump
U20213350C	MAZDA	A2C59517043	Diesel Common Rail Pump
U203-13-350	MAZDA	A2C9321760080	Diesel Common Rail Pump
U21313150	MAZDA	A2C5328876880	Distributor Pipe, fuel
Y404-13-250A	MAZDA	A2C59511612	Common Rail Diesel Injector

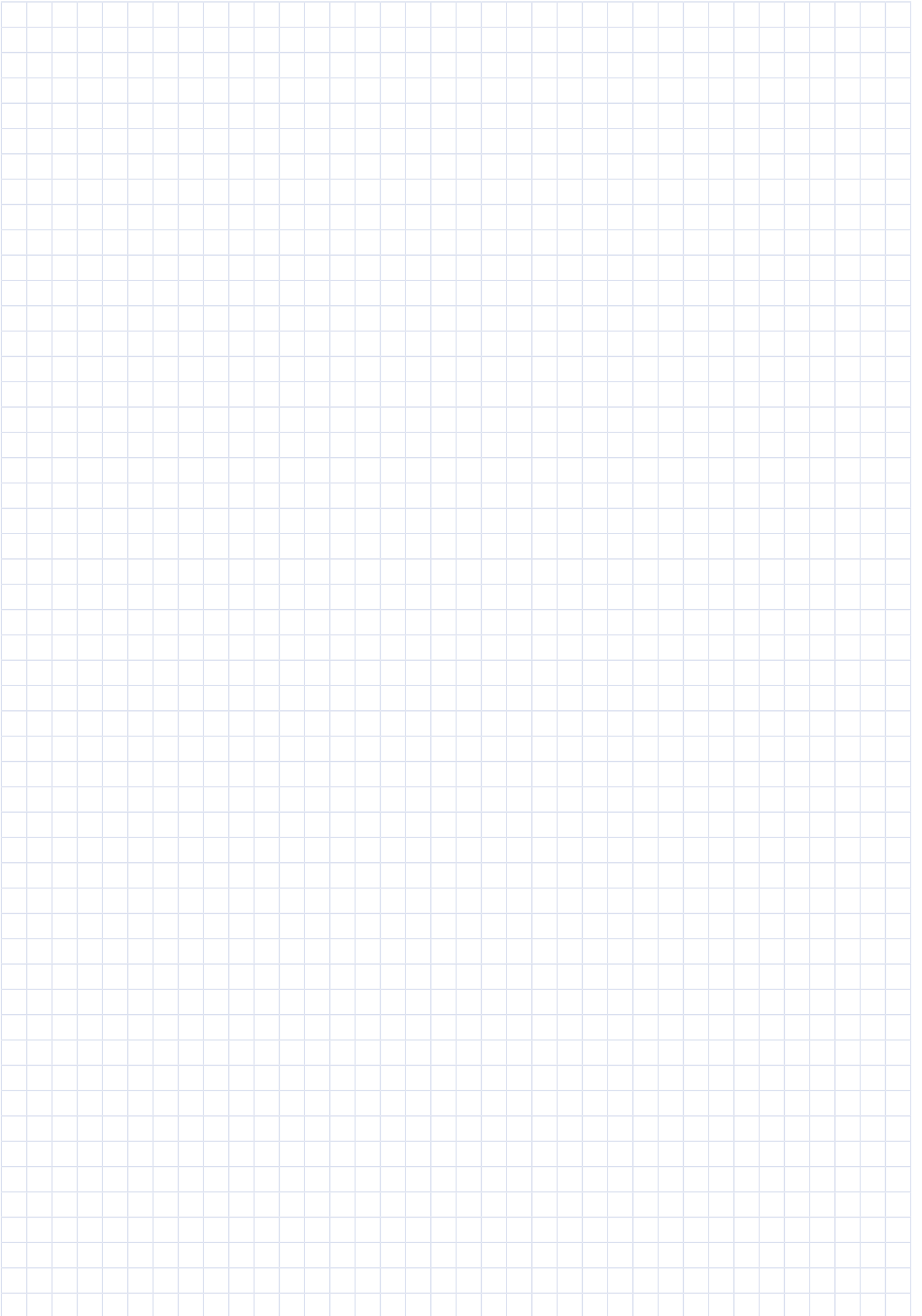



EN	
	Fitting Position
	Left
	Right
	Construction year from
	Construction year to
	Chassis number from
	Chassis number to
	Engine Code
	Colour
	Fuel Type
	Common Rail Diesel Injector
	Diesel Common Rail Pump
(C2)	Version
(C3)	Specification
(C11)	for PR number
(C20)	Model year from
(C21)	Model year to
(C27)	Observe the vehicle manufacturer specifications
(C28)	Production date from
(C29)	Production date to
(C31)	Part number of recommended accessories
(C57)	RPO number from
(C61)	for OE number
(C62)	Fuel Mixture Formation
(C68)	for article number
(C106)	Supplementary Article/Info 2
(V52)	Black
(V65)	Diesel
(V178)	with sensor
(V240)	Fuel Rail

EN	
T019	Have to be taught/updated.
T024	Mandatory - check new part against old part (in particular OE No.)
T041	Please note the classification of the injector (4, 5 or 6).



DE	
	Einbauseite
	links
	rechts
	Baujahr ab
	Baujahr bis
	Fahrgestellnummer ab
	Fahrgestellnummer bis
	Motorcode
	Farbe
	Kraftstoffart
	Common Rail Diesel Injektor
	Diesel Common Rail Pumpe
(C2)	Version
(C3)	Spezifikation
(C11)	für PR-Nummer
(C20)	Modelljahr ab
(C21)	Modelljahr bis
(C27)	Vorgaben des Fahrzeugherstellers beachten
(C28)	Produktionsdatum ab
(C29)	Produktionsdatum bis
(C31)	Artikelnummer des empfohlenen Zubehörs
(C57)	Organisationsnummer ab
(C61)	für OE-Nummer
(C62)	Kraftstoffaufbereitung
(C68)	für Artikelnummer
(C106)	Ergänzungsartikel/Ergänzende Info 2
(V52)	schwarz
(V65)	Diesel
(V178)	mit Sensor

DE	
(V240)	Kraftstoffverteilerrohr
T019	Muß angelernt/aktualisiert werden.
T024	Zwingend Alt- mit Neuteil abgleichen (insbesondere OE-Nr.)
T041	Bitte Klassifizierung des Injektors beachten (4, 5, 6, 7 oder M).

FR	
	Côté d'assemblage
	gauche
	droite
	Année à partir de
	Année jusqu'à
	N° de châssis à partir de
	N° de châssis jusqu'à
	Code moteur
	Couleur
	Type de carburant
	Injecteur diesel common rail
	Pompe diesel common rail
(C2)	Version
(C3)	Spécification
(C11)	pour numéro PR
(C20)	Année à partir de
(C21)	Année jusqu'à
(C27)	Attention aux indications du constructeurs du véhicule
(C28)	Date de production à partir de
(C29)	Date de production jusqu'à
(C31)	Référence de l'accessoire recommandé
(C57)	N° d'organisation à partir de
(C61)	pour numéro OE
(C62)	Préparation de carburant
(C68)	pour référence
(C106)	Article complémentaire / Info complémentaire 2
(V52)	noir
(V65)	Diesel
(V178)	avec capteur

FR	
(V240)	Rampe à carburant
T019	Doit être adapté/ actualisé.
T024	Vérifier impérativement que l'ancienne pièce et la neuve sont identiques (en particulier n° OE)
T041	Merci de tenir compte de la classification de l'injecteur (4, 5, 6, 7 ou M).



ES	
	Lado de montaje
	izquierda
	derecha
	año construcción desde
	año construcción hasta
	nº de chasis desde
	nº de chasis hasta
	Código de motor
	Pintura
	Tipo de combustible
	Inyectore diésel para sistemas Common Rail
	Bomba diésel para sistemas Common Rail
(C2)	Versión
(C3)	Especificación
(C11)	Número de PR
(C20)	año modelo desde
(C21)	año modelo hasta
(C27)	Observar las indicaciones del constructor
(C28)	fecha de producción desde
(C29)	fecha de producción hasta
(C31)	Nº art. de accesorio recomendado
(C57)	nº de organización desde
(C61)	para OE Nº
(C62)	Preparación del combustible
(C68)	para artículo nr.
(C106)	Artículo complementario / información complementaria 2
(V52)	negro
(V65)	Gasóleo
(V178)	con sensor

ES	
(V240)	Tubo de distribución de combustible
T019	En caso deberá instruirse/actualizarse.
T024	Es obligatorio comparar la pieza vieja con la nueva (en particular el n.º de equipamiento original (OE))
T041	Rogamos que tengan en cuenta la clasificación del inyector (4, 5, 6, 7 o M).



IT	
	Lato montaggio
	Sx
	Dx
	Anno da
	Anno fino a
	N° telaio da
	N° telaio fino a
	Codice motore
	Colore
	Tipo carburante
	Iniettor diesel common rail
	Pompe diesel common rail
(C2)	Versione
(C3)	Specificazione
(C11)	per N° PR
(C20)	Anno modello da
(C21)	Anno modello fino a
(C27)	Osservare direttive costruttore veicolo
(C28)	Data di produzione da
(C29)	Data di produzione fino a
(C31)	N° articolo accessorio consigliato
(C57)	N° organizzazione da
(C61)	per N° OE
(C62)	Preparazione carburante
(C68)	per n° articolo
(C106)	Articolo complementare/Info integrativa 2
(V52)	nero
(V65)	Diesel
(V178)	con sensore

IT	
(V240)	Tubo di distribuzione del carburante
T019	Necessita di un training/aggiornamento.
T024	È obbligatorio comparare il pezzo vecchio con quello nuovo (in particolare il no. OE)
T041	Si prega di osservare la classifica dell'iniettore (4, 5, 6,7 o M).

RU	
	Сторона установки
	слева
	справа
	Год выпуска с
	Год выпуска до
	Номер шасси с
	Номер шасси до
	Код двигателя
	Цвет
	Вид топлива
	Форсунки для систем впрыска с общим нагнетательным трубопроводом типа Common Rail
	Насосы для систем впрыска с общим нагнетательным трубопроводом типа Common Rail
(C2)	Версия
(C3)	Спецификация
(C11)	для заменяемого номера
(C20)	Модельный год от
(C21)	Модельный год до
(C27)	Обратить внимание на заданные величины производителя трансп.
(C28)	Дата производства от
(C29)	Дата производства до
(C31)	Номера артикулов рекомендуемых комплектующих
(C57)	Организационный номер от
(C61)	для оригинального номера
(C62)	Подготовка топлива
(C68)	для артикула №
(C106)	Дополнительный артикул / дополнительная информация 2
(V52)	черный

RU	
(V65)	Дизельное топливо
(V178)	с сенсором
(V240)	Разделительный топливный патрубков
T019	Необходимо обучение/ актуализация.
T024	Обязательно сравнивать старую и новую детали (в частности, номер OE)
T041	Пожалуйста, учитывайте классификацию инжектора (4, 5, 6, 7 или M).

VDO Replacement Parts

- 1 Engine actuators
- 2 Fuel systems
- 3 Sensors for engine management
- 4 Sensors for instrumentation
- 5 Sensors for tire pressure monitoring systems (TPMS)
- 6 HVAC blower and fan systems
- 7 Screen and headlight washer systems
- 8 Actuators for central locking systems
- 9 Diagnostic systems
- 10 Common Rail Diesel
- 11 Battery

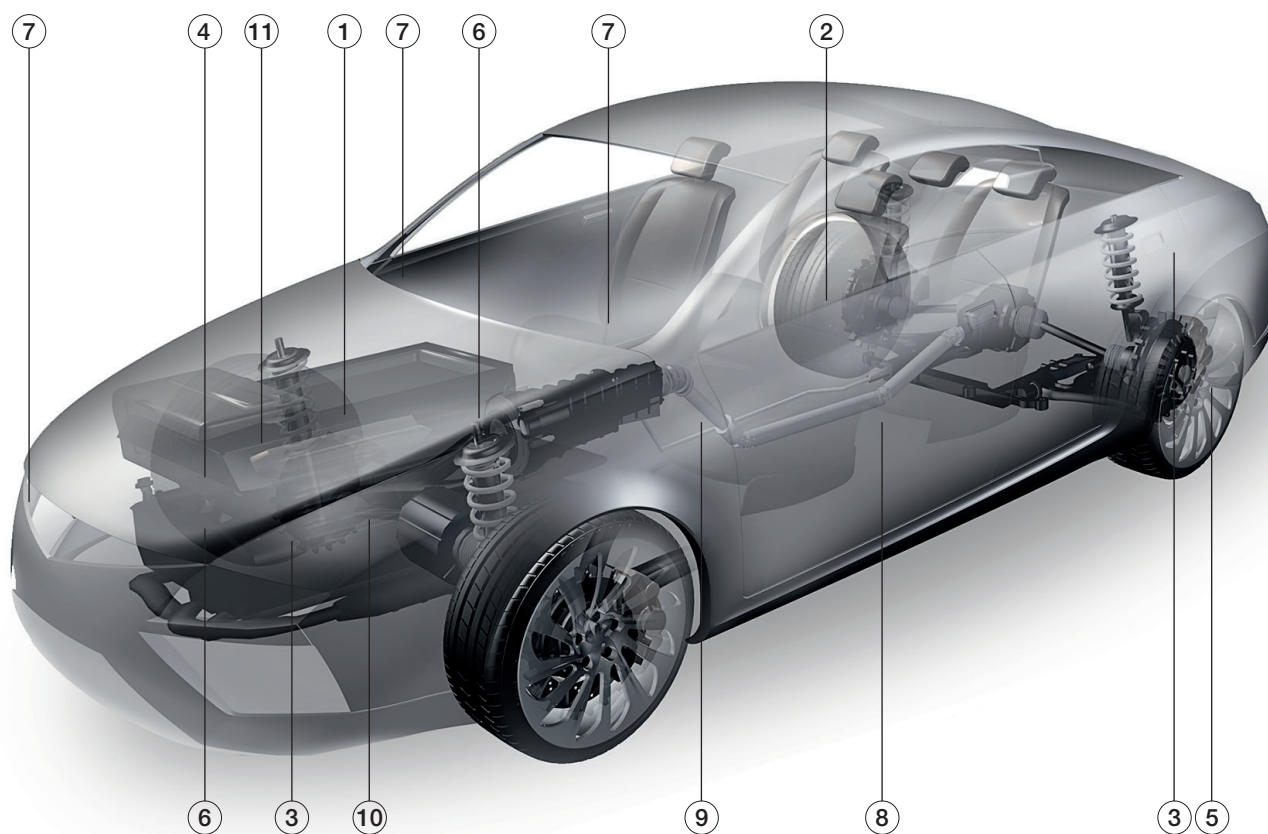

VDO Replacement Parts
Online Catalog



→ more

Online Catalog

Please consult our easy-to-use catalogs for detailed, up to date information about the replacement parts available or visit our website at: www.vdo.com



Continental is a certified
TecDoc partner.



Continental Trading GmbH

Sodener Strasse 9

D-65824 Schwalbach

Germany

Tel: + 49 6196 87-0

Fax: + 49 6196 86571

www.vdo.com

E-Mail: replacementparts@vdo.com

VDO - A Trademark of the Continental Corporation

The information provided in this brochure contains only general descriptions or performance characteristics, which do not always apply as described in case of actual use or which may change as a result of further development of the products. This information is merely a technical description of the product. This information is not meant or intended to be a special guarantee for a particular quality or a particular durability. An obligation to provide the respective characteristics shall only exist if expressly agreed in the terms of contract. We reserve the right to make changes in availability as well as technical changes without prior notice.

Please note: Application – The products described in this catalogue are designed for use in land vehicles, engines and equipment. Disclaimer – The data in this replacement parts catalogue has been compiled and processed for the purpose of presenting our replacement parts range and is correct to the best of our knowledge. Subject to technical alterations, errors and omissions. Availability is not guaranteed. We cannot be held liable with regard to any information contained in the Continental Trading replacement parts catalogue except in case of intent, gross negligence or where mandatory liability is borne in accordance with German product liability law.

© Continental Trading GmbH © 07.2019
Printed in Germany

VDO